

ARCH WIRES

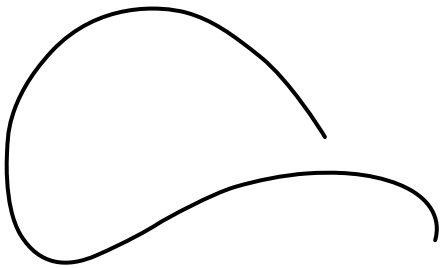
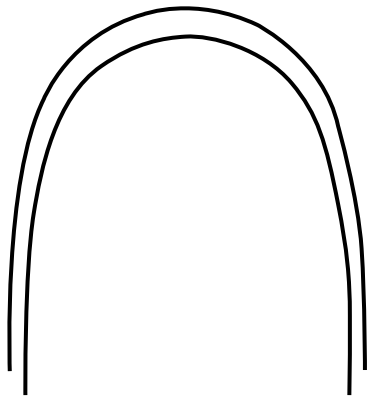
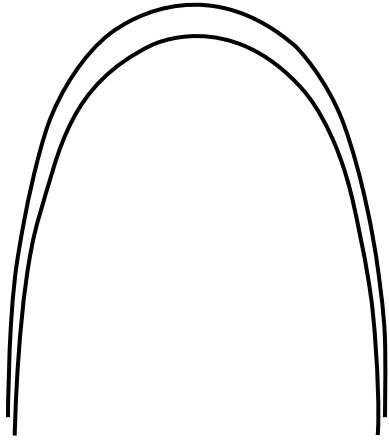

Page 1-4 Arch Forms

Page 5-6 Arch Wire Alloys and Forces

Page 7-8 Trans Thermal Heat Activated
Nickel Titanium

Page 9-10 SE Nickel Titanium

Page 11-12 Pro Force Nickel Titanium

Page 13-14 Molybdenum Titanium
Alloy – MTA

Page 15-16 Stainless Steel Resilient



The search for the ideal arch form can be documented in research and articles dating back over one hundred years and you could reasonably conclude there is no one form suitable for all patients. Relapse occurs frequently during long term retention when the arch form has been changed greatly from what the patient initially presents. This suggests that a variety of arch forms should be employed. These forms should offer shape assortment as well as varying inter-canine and inter-molar widths.

You could objectively make a case that there are three principal shapes that occur most often: **Square** or **Broad**, **Ovoid**, and **Tapered**.

Ideally each wire should be custom contoured for each patient and that is easily done in stainless steel and MTA. All types of nickel titanium alloys do not allow this, so Phoenix offers a full range of wire alloys and forces in each form that we offer. Also note that in each form the maxillary arch follows the shape of the lower arch and is 3 to 4 mm larger to provide arch wire coordination in the majority of cases.

Symmetry iP, ideal proportion arch wires, now offers three sizes of the same ovoid shape. This gives the clinician the option of larger or smaller combinations of arches as measured by inter-canine and inter-molar widths.



Square or Broad arches such as the Symmetry form that offers the most width at the canines and in the posterior.
New "Small" lower now offers a combination of cuspid and molar widths.

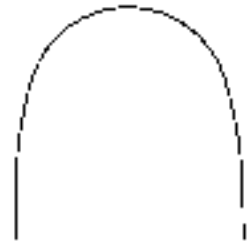

Ovoid arches like Symmetry II and Symmetry III Small that offer less cuspid widths and various amounts of posterior width.

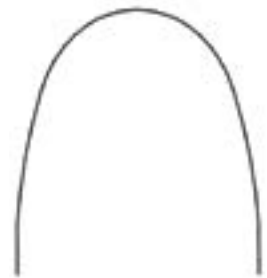

Ovoid arches like Symmetry iP offering combinations of cuspid and molar widths.

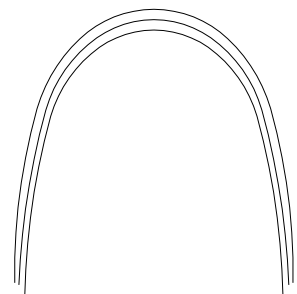

Tapered arches such as Symmetry IV Tapered.

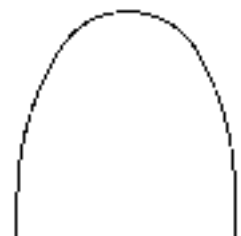



Available alloys and forces are listed in each form

SYMMETRY

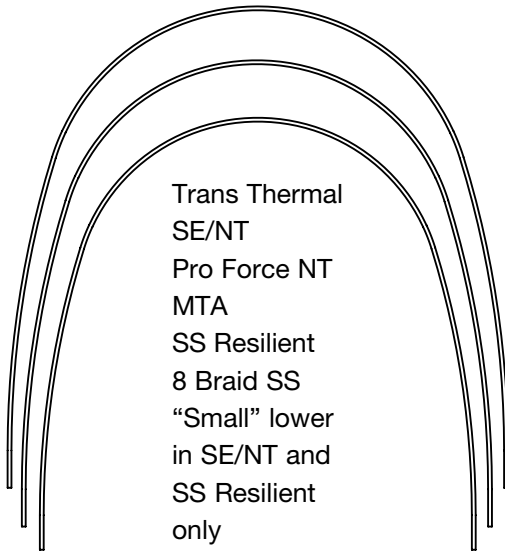

SYMMETRY II

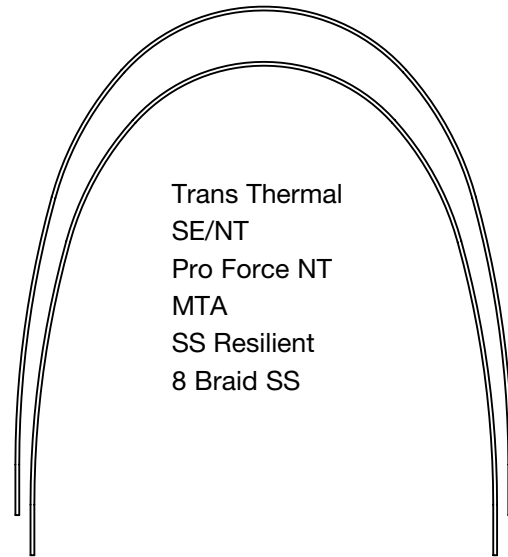

SYMMETRY III SMALL

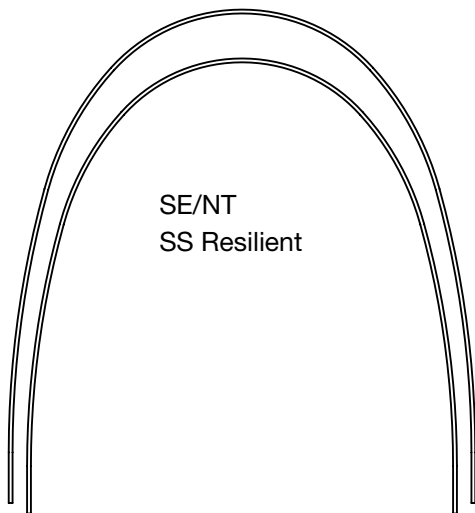

SYMMETRY IV TAPERED

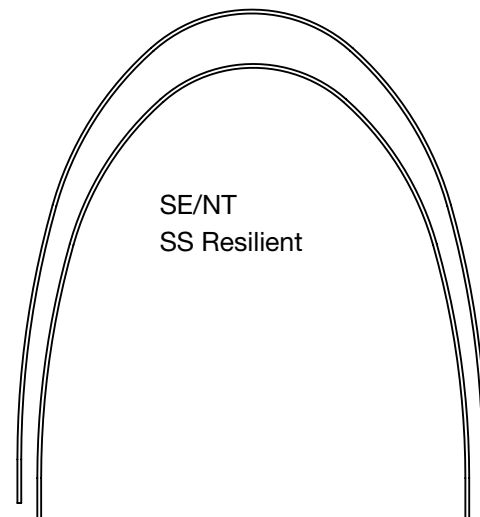



Symmetry iP now gives the clinician the option of two inter-canine and inter-molar widths in all types of alloys and forces. This allows for more customization for each patient in arch wire alloys that cannot be re-contoured.

The ovoid shapes also provide for an aesthetically finished smile without the dark areas associated with broad or square shapes.

Symmetry *iP*
ideal proportion archwires

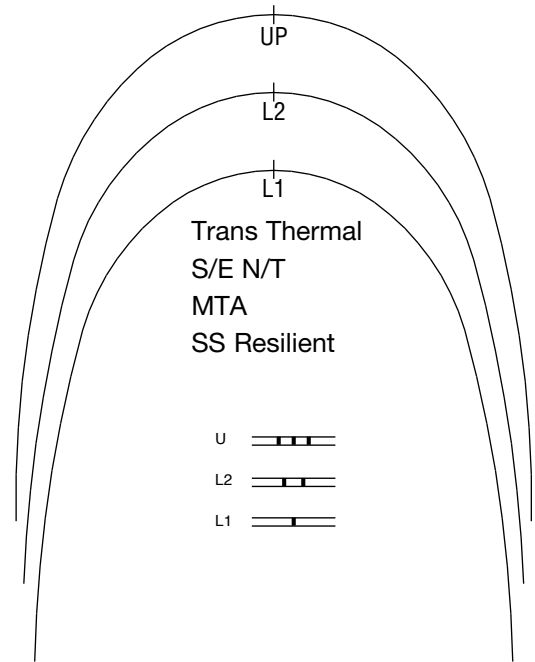

©PHOENIX ORTHODONTICS INCORPORATED, USA
All Rights Reserved 2016

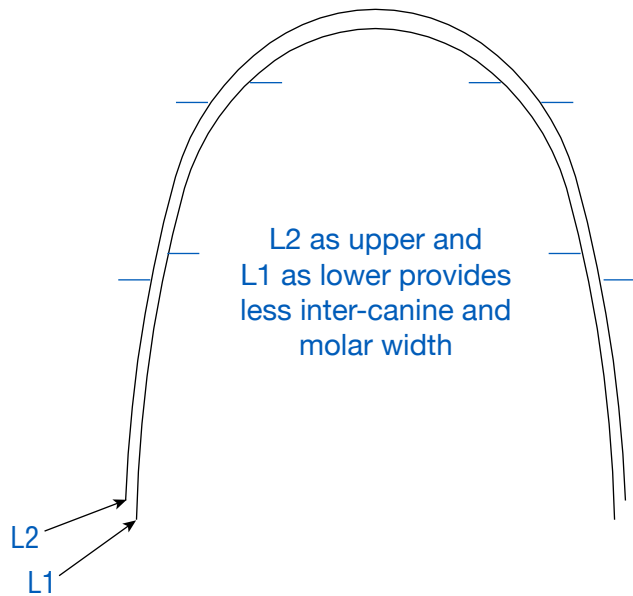

L2 as upper and L1 as lower provides less inter-canine and molar width

L2
L1

Etched Midlines

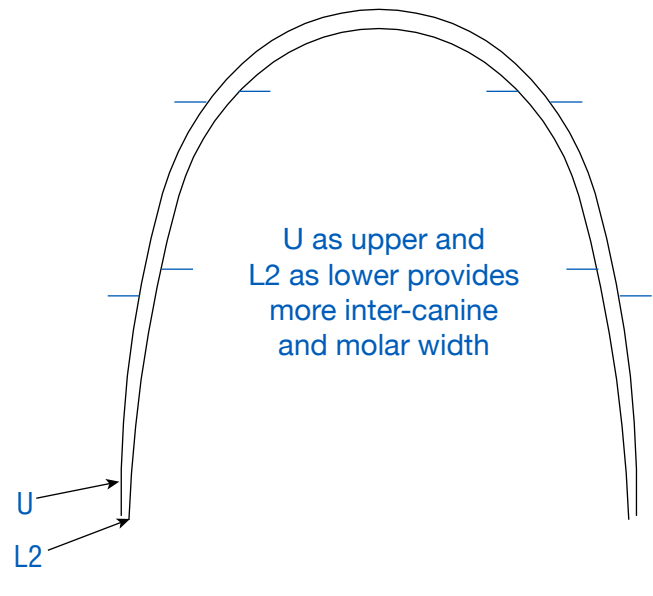

U as upper and L2 as lower provides more inter-canine and molar width

U
L2

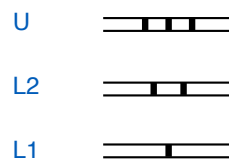

Arch Wire Alloys and Forces



Trans Thermal Heat Activated Nickel Titanium

- Light continuous forces are fully active at 95 degrees F.
- Round wires easily engage in the most severely misaligned teeth.
- Square and rectangular wires can be employed earlier in treatment for torque control in all bracket systems and especially for ceramics.
- Easy ligation at room temperatures or when chilled and complete shape memory at body temperature.

SE Nickel Titanium

- Light continuous forces at a range between Trans Thermal Heat Activated and Pro Force Nickel Titanium allows for easy engagement.
- Near constant unloading (tooth moving) forces regardless of the degree of deflection.
- Superior smooth and bright finish for reduced friction.

Pro Force Nickel Titanium

- Progressive loading and unloading forces in a moderate range that can increase efficiency and require fewer arch wire changes. The higher the degree of deflection, the greater the return or tooth moving forces.
- Highly effective in space closure/retractions, stubborn rotations, leveling and arch form development.
- Rectangular dimensions are excellent finishing wires where complete torque control is required. Detailing in the vertical and horizontal planes is accomplished with our narrow tip three prong plier.
- Our Original nickel titanium wire that delivers the force when you need it.
- Superior smooth and bright finish for reduced friction.

Molybdenum Titanium Alloy – MTA

- This special alloy provides forces midway between Pro Force Nickel Titanium and Stainless Steel while offering some memory benefit like nickel titanium and the bendability of stainless steel.
- The ideal retraction loop wire and the smooth finish reduces friction.
- Careful processing of this alloy has effectively eliminated breakage.
- Excellent torque control because of tight corner radii and cross sectional diagonal specifications.
- Long distal lengths of these arches allow for multiple loops and detailing while allowing treatment of second molars if desired.

Stainless Steel

- The highest quality 304V alloys are used to produce superior tensile strength with less brittleness that could cause breakage.
- Tight torque control at less than the industry allowable standard of up to three degrees.
- Resilient Stainless Steel offers an ultra smooth bright mirror finish.
- Resilient Plus is a heat treated, stress relieved, goldtone finish with slightly higher spring and stiffness than Resilient.

Arch Wire packaging and labeling is color matched to catalog descriptions.



Arch Wire Alloys and Forces

Trans Thermal Nickel Titanium

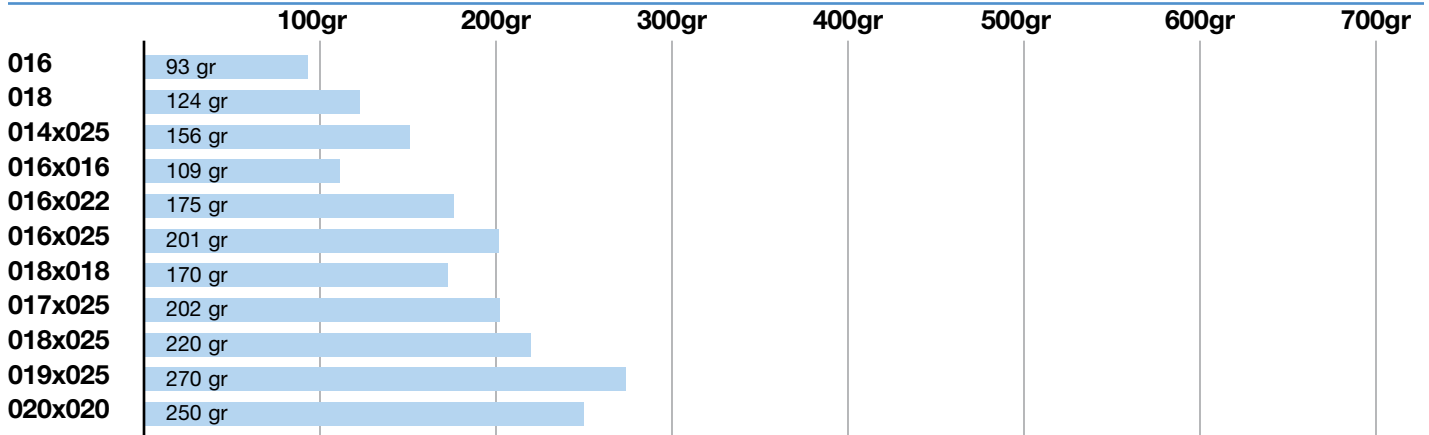

SE Nickel Titanium

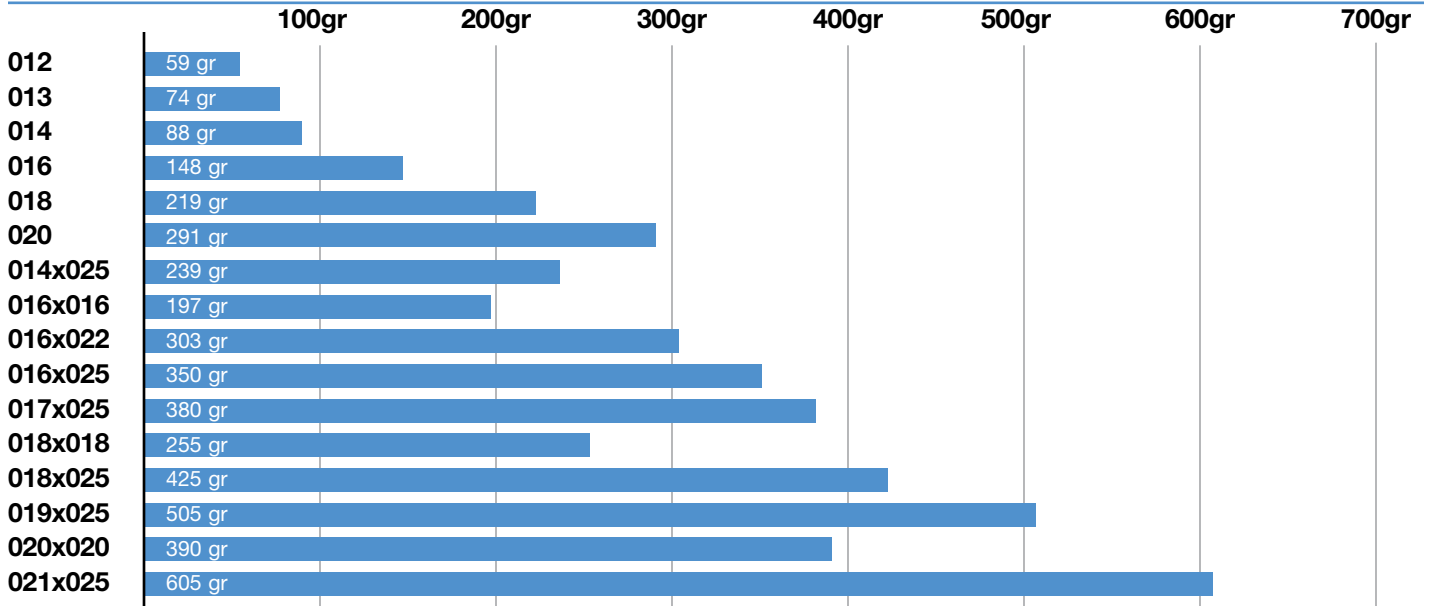

Pro Force Nickel Titanium

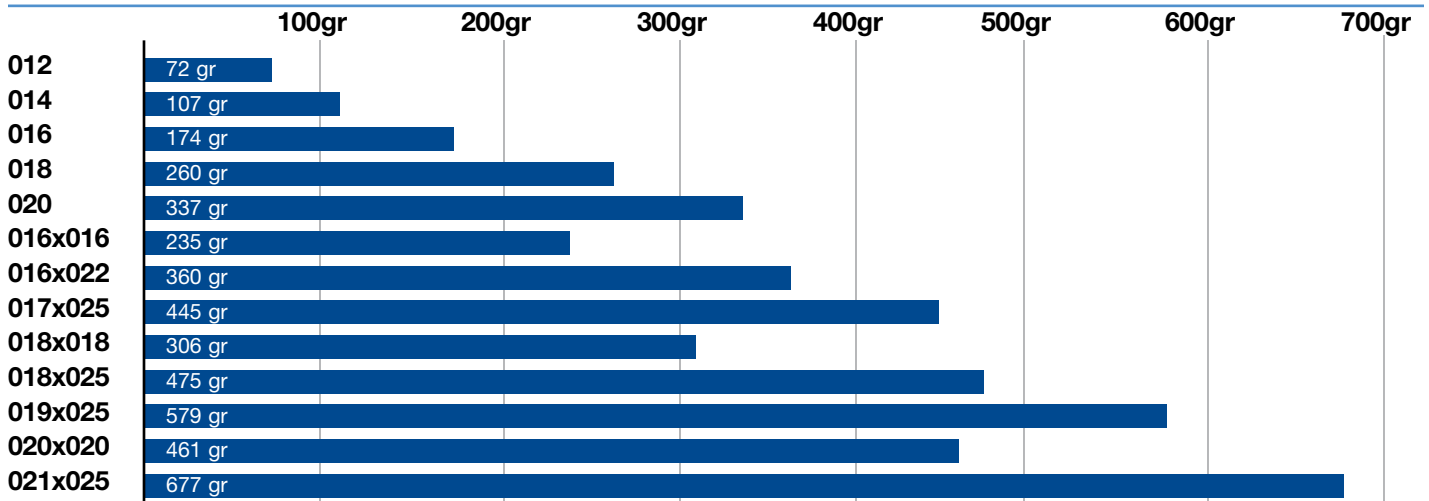

Testing Method: ANSI ADA Spec. #32, 3.1 mm deflection over a 10 mm span.

Data Capture: Unloading forces in grams at 2 mm deflection in vertical plane, rounded to nearest gram.

Sampling: Average of 10 random production lots.

Load Cell: 50 N (5098 grams) with .001 grams accuracy.

To Place Orders: 800-735-6029 • Atlanta area 770-643-8896 • Fax 770-643-1974

orders@phoenixortho.com • www.phoenixorthodonticsgeorgia.com

Trans Thermal Heat Activated Nickel Titanium



DIAMETERS	SYMMETRY	SYMMETRY II
016U	212-16U	216-16U
016L	212-16L	216-16L
018U	212-18U	216-18U
018L	212-18L	216-18L
020U	—	—
020L	—	—
014x025U	212-14x25U	—
014X025L	212-14x25L	—
016x016U	212-16x16U	216-16x16U
016x016L	212-16x16L	216-16x16L
016x022U	212-16x22U	216-16x22U
016x022L	212-16x22L	216-16x22L
016x025U	212-16x25U	—
016x025L	212-16x25L	—
017x025U	212-17x25U	216-17x25U
017x025L	212-17x25L	216-17x25L
018x018U	—	—
018x018L	—	—
018x025U	212-18x25U	216-18x25U
018x025L	212-18x25L	216-18x25L
019x025U	212-19x25U	216-19x25U
019x025L	212-19x25L	216-19x25L
020x020U	—	—
020x020L	—	—
021x025U	212-21x25U	216-21x25U
021x025L	212-21x25L	216-21x25L



Trans Thermal Heat Activated Nickel Titanium

Wire Size	Trans Thermal
013U	—
014U	—
016U	249-16U
018U	249-18U
020U	—
014x025U	249-14x25U
016x022U	249-16x22U
016x025U	249-16x25U
017x025U	249-17x25U
018x025U	249-18x25U
019x025U	249-19x25U
018x018U	249-18x18U
020x020U	249-20x20U
013L2	—
014L2	—
016L2	249-16L2
018L2	249-18L2
020L2	—
014x025L2	249-14x25L2
016x022L2	249-16x22L2
016x025L2	249-16x25L2
017x025L2	249-17x25L2
018x025L2	249-18x25L2
019x025L2	249-19x25L2
018x018L2	249-18x18L2
020x020L2	249-20x20L2
013L1	—
014L1	—
016L1	249-16L1
018L1	249-18L1
020L1	—
014x025L1	249-14x25L1
016x022L1	249-16x22L1
016x025L1	249-16x25L1
017x025L1	249-17x25L1
018x025L1	249-18x25L1
019x025L1	249-19x25L1
018x018L1	249-18x18L1
020x020L1	249-20x20L1

Center Stop Not Available

Light continuous forces

Fully active at 95°F with complete shape memory

Round wires engage easily in the most severe malocclusions

Square and rectangular wires can be employed earlier in treatment

10/Pkg.

Etched midline marks

3 upper
1 lower

* Add CS to part number to receive no drift center stop feature.
Example: 212CS – 16x22U is Symmetry form with center stop size 016x022 upper

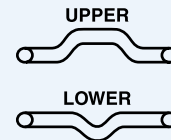

Applies to page 3-7

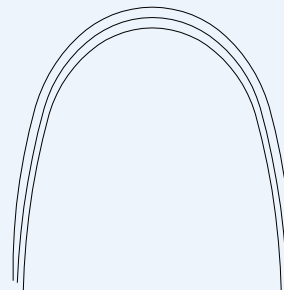

Symmetry IP
Etched Midlines

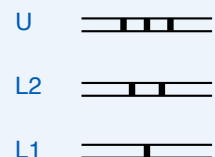

A Proprietary & Premium Product

Exclusively Phoenix-USA

SE Nickel Titanium



DIAMETERS	SYMMETRY*	SYMMETRY SMALL	SYMMETRY II*	SYMMETRY III SMALL	SYMMETRY IV TAPERED	ORIGINAL RCS ⁽¹⁾
012U	205-12U	—	206-12U	234-12U	235-12U	—
012L	205-12L	—	206-12L	234-12L	235-12L	—
014U	205-14U	—	206-14U	234-14U	235-14U	236-14U
014L	205-14L	205SM-14L	206-14L	234-14L	235-14L	236-14L
016U	205-16U	—	206-16U	234-16U	235-16U	236-16U
016L	205-16L	205SM-16L	206-16L	234-16L	235-16L	236-16L
018U	205-18U	—	206-18U	234-18U	235-18U	236-18U
018L	205-18L	205SM-18L	206-18L	234-18L	235-18L	236-18L
020U	205-20U	—	206-20U	234-20U	235-20U	236-20U
020L	205-20L	205SM-20L	206-20L	234-20L	235-20L	236-20L
014x025U	205-14x25U	—	206-14x25U	—	—	—
014x025L	205-14x25L	—	206-14x25L	—	—	—
016x016U	205-16x16U	—	206-16x16U	234-16x16U	235-16x16U	236-16x16U
016x016L	205-16x16L	—	206-16x16L	234-16x16L	235-16x16L	236-16x16L
016x022U	205-16x22U	—	206-16x22U	234-16x22U	235-16x22U	236-16x22U
016x022L	205-16x22L	205SM-16x22L	206-16x22L	234-16x22L	235-16x22L	236-16x22L
016x025U	205-16x25U	—	206-16x25U	—	—	—
016x025L	205-16x25L	—	206-16x25L	—	—	—
017x025U	205-17x25U	—	206-17x25U	234-17x25U	235-17x25U	236-17x25U
017x025L	205-17x25L	205SM-17x25L	206-17x25L	234-17x25L	235-17x25L	236-17x25L
018x018U	205-18x18U	—	206-18x18U	—	—	—
018x018L	205-18x18L	—	206-18x18L	—	—	—
018x025U	205-18x25U	—	206-18x25U	234-18x25U	235-18x25U	236-18x25U
018x025L	205-18x25L	205SM-18x25L	206-18x25L	234-18x25L	235-18x25L	236-18x25L
019x025U	205-19x25U	—	206-19x25U	234-19x25U	235-19x25U	236-19x25U
019x025L	205-19x25L	205SM-19x25L	206-19x25L	234-19x25L	235-19x25L	236-19x25L
020x020U	205-20x20U	—	206-20x20U	—	—	—
020x020L	205-20x20L	—	206-20x20L	—	—	—
021x025U	205-21x25U	—	206-21x25U	234-21x25U	—	—
021x025L	205-21x25L	—	206-21x25L	234-21x25L	—	—
				Center Stop Not Available	Center Stop Not Available	Center Stop Not Available



Wire Size	SE Nickel Titanium
013U	245-13U
014U	245-14U
016U	245-16U
018U	245-18U
020U	245-20U
014x025U	245-14x25U
016x022U	245-16x22U
016x025U	245-16x25U
017x025U	245-17x25U
018x025U	245-18x25U
019x025U	245-19x25U
018x018U	245-18x18U
020x020U	245-20x20U
013L2	245-13L2
014L2	245-14L2
016L2	245-16L2
018L2	245-18L2
020L2	245-20L2
014x025L2	245-14x25L2
016x022L2	245-16x22L2
016x025L2	245-16x25L2
017x025L2	245-17x25L2
018x025L2	245-18x25L2
019x025L2	245-19x25L2
018x018L2	245-18x18L2
020x020L2	245-20x20L2
013L1	245-13L1
014L1	245-14L1
016L1	245-16L1
018L1	245-18L1
020L1	245-20L1
014x025L1	245-14x25L1
016x022L1	245-16x22L1
016x025L1	245-16x25L1
017x025L1	245-17x25L1
018x025L1	245-18x25L1
019x025L1	245-19x25L1
018x018L1	245-18x18L1
020x020L1	245-20x20L1

Center Stop Not Available

SE Nickel Titanium

Light continuous forces at a range between Trans Thermal and Pro Force Nickel Titanium allows for easy engagement.

Near constant unloading (tooth moving) forces regardless of the degree of deflection.

10/Pkg.

Etched midline marks
3 upper
1 lower

"Small" lower has one etched mid line and an additional etch mark 20 mm distal of mid line on right side.

** Add CS to part number to receive no drift center stop feature.*

Example: 226CS-14U is Symmetry III form with center stop size 014 upper

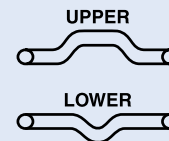

Applies to page 3-9

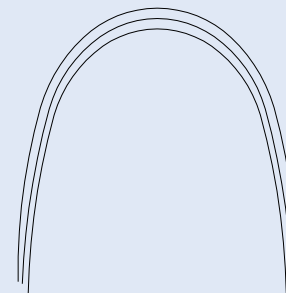

Symmetry *IP*
Etched Midlines



⁽¹⁾ SE Original RCS has moderate curve of spee, lingual crown torque, and distal toe-in.

A Proprietary & Premium Product

Exclusively Phoenix-USA

Pro Force Nickel Titanium



DIAMETERS	SYMMETRY*	SYMMETRY II*
012U	200-12U	201-12U
012L	200-12L	201-12L
014U	200-14U	201-14U
014L	200-14L	201-14L
016U	200-16U	201-16U
016L	200-16L	201-16L
018U	200-18U	201-18U
018L	200-18L	201-18L
020U	200-20U	201-20U
020L	200-20L	201-20L
016x016U	200-16x16U	201-16x16U
016x016L	200-16x16L	201-16x16L
016x022U	200-16x22U	201-16x22U
016x022L	200-16x22L	201-16x22L
—	—	—
—	—	—
017x025U	200-17x25U	201-17x25U
017x025L	200-17x25L	201-17x25L
018x018U	200-18x18U	201-18x18U
018x018L	200-18x18L	201-18x18L
018x025U	200-18x25U	201-18x25U
018x025L	200-18x25L	201-18x25L
019x025U	200-19x25U	201-19x25U
019x025L	200-19x25L	201-19x25L
020x020U	200-20x20U	201-20x20U
020x020L	200-20x20L	201-20x20L
021x025U	200-21x25U	201-21x25U
021x025L	200-21x25L	201-21x25L



**ORIGINAL
RCS ⁽²⁾**

**"H" TYPE
RCS ⁽¹⁾**

—	—
—	—
—	208-14U
—	208-14L
207-16U	208-16U
207-16L	208-16L
207-18U	208-18U
207-18L	208-18L
207-20U	208-20U
207-20L	208-20L
207-16x16U	208-16x16U
207-16x16L	208-16x16L
207-16x22U	208-16x22U
207-16x22L	208-16x22L
—	208-16x25U
—	208-16x25L
207-17x25U	208-17x25U
207-17x25L	208-17x25L
—	—
—	—
—	208-18x25U
—	208-18x25L
207-19x25U	208-19x25U
207-19x25L	208-19x25L
—	—
—	—
207-21x25U	—
207-21x25L	—

**Center Stop
Not Available**

**Center Stop
Not Available**

⁽¹⁾ "H" Type RCS has straight posterior sections, no lingual crown torque, and the deepest curve of spee.

⁽²⁾ Original RCS offers the most distal toe-in to control molar rotation in extraction cases and moderate curve of spee and lingual crown torque.

***CENTER STOP AVAILABLE**

Pro Force Nickel Titanium

Progressive loading and unloading forces in a moderate range that can increase efficiency and require fewer arch wire changes. The higher the degree of deflection, the greater the return or tooth moving forces.

Highly effective in space closure/retractions, stubborn rotations, leveling and arch form development.

Rectangular dimensions are excellent finishing wires where complete torque is desired.

Detailing in the vertical and horizontal planes is accomplished with our narrow tip three prong plier.

Our original Nickel Titanium wire that delivers the force when you need it.

10/Pkg.

Etched midlines
3 upper
1 lower

* Add CS to part number to receive no drift center stop feature.
Example: 201CS-16x22U is Symmetry II form with center stop size 016x022 upper

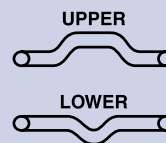

Applies to page 3-11

Molybdenum Titanium Alloy – MTA



DIAMETERS SYMMETRY SYMMETRY II

012U	—	—
012L	—	—
014U	—	—
014L	—	—
016U	250-16U	252-16U
016L	250-16L	252-16L
018U	250-18U	252-18U
018L	250-18L	252-18L
020U	—	—
020L	—	—
016x016U	250-16x16U	252-16x16U
016x016L	250-16x16L	252-16x16L
016x022U	250-16x22U	252-16x22U
016x022L	250-16x22L	252-16x22L
017x025U	250-17x25U	252-17x25U
017x025L	250-17x25L	252-17x25L
018x018U	250-18x18U	252-18x18U
018x018L	250-18x18L	252-18x18L
018x025U	250-18x25U	252-18x25U
018x025L	250-18x25L	252-18x25L
019x025U	250-19x25U	252-19x25U
019x025L	250-19x25L	252-19x25L
020x020U	—	—
020x020L	—	—
021x025U	250-21x25U	252-21x25U
021x025L	250-21x25L	252-21x25L

**SYMMETRY
“M” LOOP**



250-M-16x22

250-M-17x25

250-M-19x25

- Space Closure
 - Anterior Retraction and/or intrusion
 - Reduced Force Decay compared to Stainless Steel
 - Upper Sizes 36-46 mm (no 44) and 52 and 56 mm
 - Lower Sizes 24-34 mm
- 5/Pkg.



Wire Size	MTA
013U	—
014U	—
016U	—
018U	—
020U	—
014x025U	—
016x022U	254-16x22U
016x025U	—
017x025U	254-17x25U
018x025U	254-18x25U
019x025U	254-19x25U
018x018U	—
020x020U	—
013L2	—
014L2	—
016L2	—
018L2	—
020L2	—
014x025L2	—
016x022L2	254-16x22L2
016x025L2	—
017x025L2	254-17x25L2
018x025L2	254-18x25L2
019x025L2	254-19x25L2
018x018L2	—
020x020L2	—
013L1	—
014L1	—
016L1	—
018L1	—
020L1	—
014x025L1	—
016x022L1	254-16x22L1
016x025L1	—
017x025L1	254-17x25L1
018x025L1	254-18x25L1
019x025L1	254-19x25L1
018x018L1	—
020x020L1	—

Center Stop Not Available

Molybdenum Titanium Alloy – MTA

This special alloy provides forces midway between Pro Force Nickel Titanium and Stainless Steel, while offering some of the memory benefit of Nickel Titanium and the bendability of Stainless Steel.

Careful processing of this alloy has effectively eliminated breakage.

Excellent for torque control

The ideal retraction loop wire and the smooth finish reduces friction.

Long distal lengths of arches allows for multiple loops and detailing, and the treatment of second molars if desired.

10/Pkg.

Etched midlines
3 upper
1 lower

Applies to page 3-13

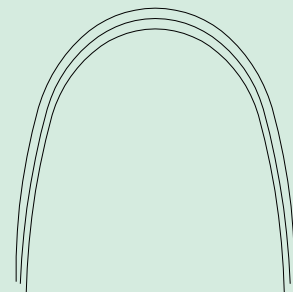

Symmetry^{IP}
Etched Midlines

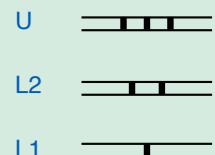

A Proprietary & Premium Product

Exclusively Phoenix-USA

Stainless Steel Resilient



DIAMETERS	SYMMETRY*	SYMMETRY SMALL	SYMMETRY II*	SYMMETRY III SMALL	SYMMETRY IV TAPERED
012U	—	—	—	—	—
012L	—	—	—	—	—
014U	100-14U	—	101-14U	141-14U	117-14U
014L	100-14L	100SM-14L	101-14L	141-14L	117-14L
016U	100-16U	—	101-16U	141-16U	117-16U
016L	100-16L	100SM-16L	101-16L	141-16L	117-16L
018U	100-18U	—	101-18U	141-18U	117-18U
018L	100-18L	100SM-18L	101-18L	141-18L	117-18L
020U	100-20U	—	101-20U	141-20U	117-20U
020L	100-20L	100SM-20L	101-20L	141-20L	117-20L
016x016U	100-16x16U	—	101-16x16U	141-16x16U	117-16x16U
016x016L	100-16x16L	—	101-16x16L	141-16x16L	117-16x16L
016x022U	100-16x22U	—	101-16x22U	141-16x22U	117-16x22U
016x022L	100-16x22L	100SM-16x22L	101-16x22L	141-16x22L	117-16x22L
016x025	—	—	—	—	—
017x022U	100-17x22U	—	—	—	—
017x022L	100-17x22L	—	—	—	—
017x025U	100-17x25U	100SM-17x25L	101-17x25U	141-17x25U	117-17x25U
017x025L	100-17x25L	—	101-17x25L	141-17x25L	117-17x25L
018x018U	—	—	—	—	—
018x018L	—	—	—	—	—
018x022U	100-18x22U	—	101-18x22U	—	—
018x022L	100-18x22L	—	101-18x22L	—	—
018x025U	100-18x25U	—	101-18x25U	141-18x25U	117-18x25U
018x025L	100-18x25L	100SM-18x25L	101-18x25L	141-18x25L	117-18x25L
019x025U	100-19x25U	—	101-19x25U	141-19x25U	117-19x25U
019x025L	100-19x25L	100SM-19x25L	101-19x25L	141-19x25L	117-19x25L
020x020U	—	—	—	—	—
020x020L	—	—	—	—	—
021x025U	100-21x25U	—	101-21x25U	141-21x25U	117-21x25U
021x025L	100-21x25L	—	101-21x25L	141-21x25L	117-21x25L



Wire Size	Stainless Steel
013U	—
014U	124-14U
016U	124-16U
018U	124-18U
020U	—
014x025U	—
016x022U	124-16x22U
016x025U	—
017x025U	124-17x25U
018x025U	124-18x25U
019x025U	124-19x25U
018x018U	—
020x020U	124-20x20U
013L2	—
014L2	124-14L2
016L2	124-16L2
018L2	124-18L2
020L2	—
014x025L2	—
016x022L2	124-16x22L2
016x025L2	—
017x025L2	124-17x25L2
018x025L2	124-18x25L2
019x025L2	124-19x25L2
018x018L2	—
020x020L2	124-20x20L2
013L1	—
014L1	124-14L1
016L1	124-16L1
018L1	124-18L1
020L1	—
014x025L1	—
016x022L1	124-16x22L1
016x025L1	—
017x025L1	124-17x25L1
018x025L1	124-18x25L1
019x025L1	124-19x25L1
018x018L1	—
020x020L1	124-20x20L1

Stainless Steel Resilient

Ultra smooth bright mirror finish

Torque control at less than the industry allowable 3°

100 Round/Pkg.
10 Square or Rectangular/Pkg.

Etched midlines

3 upper
1 lower

“Small” lower has one etched mid line and an additional etch mark 20 mm distal of mid line on right side.

Applies to page 3-15

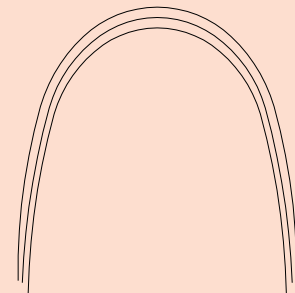

Symmetry^{IP}
Etched Midlines

