

PHOENIX ORTHODONTICS

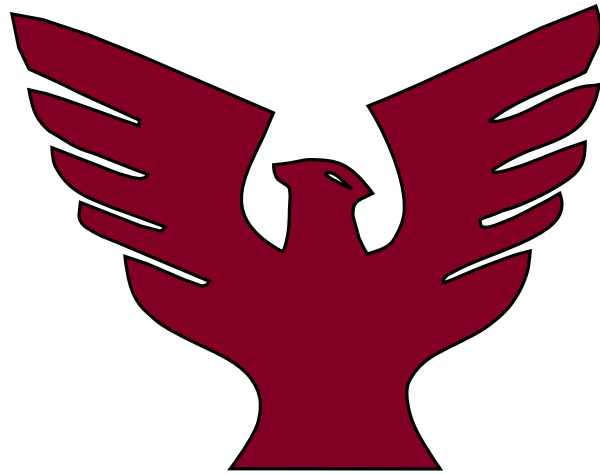

Since 1990

Volume 9.1



PHOENIX
ORTHODONTICS

Since 1990

Phoenix Premium Grade Archwires, Force and Appliance Systems provide consistent, reliable and predictable performance.

Enhance your clinical efficiency.

Achieve your treatment goals on time, with excellent results and greater patient comfort with a wide range of Phoenix products.

www.phoenixorthodonticsgeorgia.com

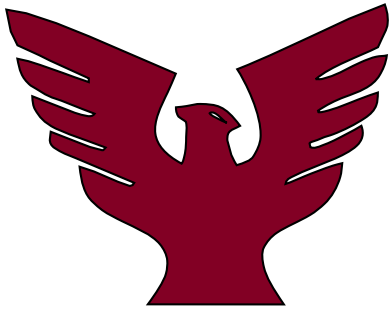

PHOENIX
ORTHODONTICS

Since 1990



Made in USA

We estimate over 98% of our products are made in the USA. Country of origin is provided for those products that are the exception.

Our focus at Phoenix from the beginning has been to provide the highest quality products available with outstanding service at a reasonable cost. This combination and your support has allowed us to grow and offer an even wider assortment of products. All are designed to advance clinical efficiency and in many instances increase patient comfort. We welcome your thoughts as we continue to work towards your complete satisfaction.

Phoenix Orthodontics Inc.
P.O. Box 71773
Marietta, GA 30007

Toll Free: 800-735-6029
Phone: 770-643-8896
Fax: 770-643-1974

orders@phoenixorthoga.com

www.phoenixorthodonticsgeorgia.com

TERMS

Payment is due within 30 days of the shipping date. An itemized invoice is provided with each shipment. Any unpaid balance after 30 days is subject to a 1½% per month finance charge. Invoices may be paid by business or personal check, Visa, or MasterCard.

SHIPPING

Most orders placed before 2:00 p.m. Eastern Time are shipped UPS that day, F.O.B. Roswell, Georgia. Reasonable shipping and insurance is added to your invoice. Ground delivery reaches most of our customers in one or two days. Expedited shipping is available for only the actual increase in shipping cost.

EXCHANGES AND RETURNS

We want you to be completely satisfied with our products. Should you feel a return or exchange is necessary, call us within 60 days of the invoice date. We will issue a return authorization number to you.

Return the product with the matching invoice along with a note explaining the reason for the return. Insure the return for its invoiced value. All products must be in original packaging and in resalable condition. We reserve the right to final determination as to acceptance of product for exchange or credit.

Pre-welded band assemblies and other custom ordered and produced items are not returnable.

SECTION 1 – BRACKET SYSTEMS

Page 1-2	Phoenix Optimal 2x Twin Bracket System
Page 3-4	Crystal Clear Twin Ceramic System
Page 5-7	Value Line System

SECTION 2 – BUCCAL TUBES FOR BONDING AND WELDING

Page 1-2	Optimal 2x Ultra Low Profile Bondable Buccal Tubes	Page 9	“Original” Series Molar Bands
Page 3	Optimal 2x Bondable Convertible Low Profile Buccal Tubes	Page 10	“M” Series Molar Bands
Page 4	Optimal Mini 2nd Molar Bondable Tubes	Page 11	Weldable Lingular Attachments
Page 5	Mini Bondable 2nd Tubes, Low Friction Tubes, Bondable Auxiliaries		
Page 6	Auxiliaries		
Page 7	Convertible Buccal Tubes – Torque in Base		
Page 8	Optimal 2x Ultra Low Profile Weldable Buccal Tubes		

SECTION 3 – ARCH WIRES

Page 1-4	Arch Forms
Page 5-6	Arch Wire Alloys and Forces
Page 7-8	Trans Thermal Heat Activated Nickel Titanium
Page 9-10	SE Nickel Titanium
Page 11-12	Pro Force Nickel Titanium
Page 13-14	Molybdenum Titanium Alloy – MTA
Page 15-16	Stainless Steel Resilient

SECTION 4 – SPECIAL WIRES AND WIRE AUXILIARIES

Page 1	Nickel Titanium Open Coil Springs, Distalizing Springs
Page 2	Nickel Titanium Closed Coil Springs, Stainless Steel Open and Closed Coil Springs
Page 3	Arch Wire Stops
Page 4	Arch Wire Hooks
Page 5	Nickel Titanium Torquing Wires
Page 6	Stainless Steel Specialty Wires, 8 Braid, Co-Axial and Twist
Page 7	Stainless Steel Short and Long Ligature Wires and Kobayashi Hooks
Page 8	SE Nickel Titanium 15' Spools, N/T Separating Springs, and Anterior Torquing Springs
Page 9-10	Basic Arch Forms, Nickel Titanium and Stainless Steel

SECTION 5 – ELASTOMERIC FORCE SYSTEMS AND AUXILIARIES

Page 1	Straight, Key, and Single Use Ties
Page 2	Color Chart for Ties and Chain Elastic
Page 3	Chain Elastic, Solid and Hollow Threads, Arch Wire Sleeve
Page 4	Phoenix Intra-Oral Elastics – Natural Amber and Neon, Extra Oral Latex Elastics, Elastic Attachers
Page 5	Phoenix Latex Free Elastics, Radiopaque Separators
Page 6	Endura High Performance Chain

SECTION 6 – LAB SUPPLIES

Page 1	Leone 620 Palatal Expanders	Page 9	Preformed Lip Bumper with Loops, Thermal Insulator Paste
Page 2	Leone Palatal Expanders with Pre-Bent Arms	Page 10	Silver Solder, Solder Flux, Disposable Impression Trays
Page 3	Leone Micro Palatal Expanders	Page 11	Select Retainer Cases
Page 4	Leone Lower Arch Expanders, Fan Type Expanders	Page 12	Mini Retainer Cases, Standard Retainer Cases
Page 5	Micro Palatal Expander “Easy Access”		
Page 6	Leone Self Activating Nitinol Leaf Expanders, Gauge		
Page 7	Flat Bow Retainer Wires, Adams Clasps		
Page 8	Lab Wires – Stainless Steel, Blue Temp, MTA, Ball Clasps		

SECTION 7 – RELIANCE ADHESIVES AND BONDING ACCESSORIES

Page 1	Light Bond™, Go To®, Pad Lock®
Page 2	LCR Light Cure™ Retainer, Band-Lok®, Ultra Band-Lok®
Page 3	Flow Tain™, Pro Seal®, L.E.D. Pro Seal®, Assure® Sealant, Assure® Plus
Page 4	Ortho FlexTech®, Sponge Pellets, Mixing Pads, Mixing Spatulas, Porcelain Conditioner
Page 5	Metal Primer, Plastic Conditioner, Blue Gel Etch Syringe, Gel Etch 9 gm, Liquid Etch 9 gm, Liquid Etch 23 gm
Page 6	Green Etch Syringe, Porc-Etch™ w/Barrier Gel, 1st & Final, Bond A Braid®, Renew Metal Burs and Finishing Points
Page 7	T.K.O. Bite Turbo Gel, Microbrushes, Long Primer Brushes, Carpule (Tips) Dispensing Gun
Page 8	Mini Mold™ Kits, Access Cheek Retractor

SECTION 8 – HEAD GEAR AND AUXILIARIES

Page 1	Protraction Face Mask, Extra Oral Elastics
Page 2	Regular and Short Facebows
Page 3	Plain Inner Facebows and Bite Plate Facebows
Page 4	Angled Outer Facebows, Safety Release Modules, Neck Pads
Page 5	High Pull Head Caps, Kit Cases

SECTION 9 – INSTRUMENTS

Page 1	Introduction, Warranty, Sterilization Recommendations
Page 2	Distal, Ligature, and Hard Wire Cutters, Bird Beak and Tweed
Page 3	Three Prong, Band Remover, Arch Contouring, Angled Weingardt, Angled and Straight Bracket Remover, “V” Stop Plier for NiTi, NiTi Distal Bending
Page 4	Adhesive Removing and Separating Pliers, Mathieus, Bracket Holders, Coon Ligature, Angled Hook Crimping Pliers
Page 5	Cap Removing Plier, HD Explorer for Elastics Removing and SLB Opening, Boone Gauge, DSX Lubricant
Page 6	Bracket Holder, Bondable Tube Holders, Pusher/Scaler

SECTION 10 – COMFORT AND SAFETY

Page 1	Patient Wax, Chewies™ Aligner Tray Seaters
Page 2	Ultra-Guard® Mouth Guards

SECTION 11 – MISCELLANEOUS AND STORAGE

Page 1	Disposable Arch Markers, Bracket Organizer, Bracket Organizer Cabinet
Page 2	Disposable Bonding Pad, Chain Dispenser
Page 3	Stand Up Arch Wire Rack, Superior Arch Wire Racks

SECTION 12 – ORDER FORMS

Page 1	Bracket/Tubes Auxiliary Order Form
Page 2	Arch Wires Order Form
Page 3	iP Arch Wires Order Form
Page 4	Elastomeric Force Systems Order Form
Page 5	“Original” Series Order Form, Bands
Page 6	“M” Series Order Form, Bands



Page 1-2 Phoenix Optimal 2x Twin Bracket System



Page 3-4 Crystal Clear Twin Ceramic System



Page 5-7 Value Line Twin System



Phoenix Optimal 2x Twin Bracket System



A low profile system with rounded facial contours for patient comfort. Clinicians benefit from enhanced design features provided by state-of-the-art metal injection molding (MIM) manufacturing.



- Rhomboid bracket and pad design.
- Permanent ID marks enhanced with a full color code system assists accurate bonding preparation.
- Recessed center scribe line aids positioning and seating.



- True compound contour brackets and bases with specific anatomy matching the middle one third of each tooth. A better fit and a stronger bond.
- Fully radiused slot contact points reduce binding of wires in rotations and vertical discrepancies.



- Easy ligation tie wing areas.
- Level slot alignment with torque in base reduces arch wire finishing bends.



- Micro etched 80 gauge mesh increases shear strength by 35% and provides a color contrast when applying adhesive, assuring complete coverage.

Offset – Standard Bicuspids



- Brazing alloy is steel colored for a premium finish and is highly tarnish resistant.



Phoenix Optimal 2x Twin Bracket System

Maxillary	Torque	Angulation	Width mm	In/Out mm	ID	.018 Slot	.022 Slot
Central	22	5	3.5	0.91	●	511-181UR/22 511-181UL/22	511-221UR/22 511-221UL/22
Central	17	4	3.5	0.91	●	511-181UR/17 511-181UL/17	511-221UR/17 511-221UL/17
Central	12	5	3.5	0.91	●	511-181UR/12 511-181UL/12	511-221UR/12 511-221UL/12
Lateral	10	8	2.9	1.27	●	511-182UR/10 511-182UL/10	511-222UR/10 511-222UL/10
Lateral	8	9	2.9	1.27	●	511-182UR/8 511-182UL/8	511-222UR/8 511-222UL/8
Cuspid HK	-7	8	3.0	0.84	●	511-183URHK 511-183ULHK	511-223URHK 511-223ULHK
Cuspid HK	0	8	3.0	0.84	●	511-183URHK/OT 511-183ULHK/OT	511-223URHK/OT 511-223ULHK/OT
Bicuspid	-7	0	3.0	0.84	●	511-184,5U	511-224,5U
Bicuspid HK	-7	0	3.0	0.84	●	511-184,5URHK 511-184,5ULHK	511-224,5URHK 511-224,5ULHK
Bicuspid Offset	-7	0	3.0	0.84	●	511-184,5UOF	511-224,5UOF
Bicuspid Offset HK	-7	0	3.0	0.84	●	511-184,5UROFHK 511-184,5ULOFHK	511-224,5UROFHK 511-224,5ULOFHK

Mandibular	Torque	Angulation	Width mm	In/Out mm	ID	.018 Slot	.022 Slot
Anteriors	-6	0	2.5	1.27	●	511-181,2/-6	511-221,2/-6
Anteriors	0	0	2.5	1.27	●	511-181,2/0	511-221,2/0
Cuspid HK	-6	3	3.0	0.81	●	511-183LRHK 511-183LLHK	511-223LRHK 511-223LLHK
Cuspid HK	0	3	3.0	0.81	●	511-183LRHK/OT 511-183LLHK/OT	511-223LRHK/OT 511-223LLHK/OT
1st Bicuspid	-12	0	3.0	0.81	●	511-184L	511-224L
1st Bicuspid HK	-12	0	3.0	0.81	●	511-184LRHK 511-184LLHK	511-224LRHK 511-224LLHK
1st Bicuspid Offset	-12	0	3.0	0.81	●	511-184LOF	511-224LOF
1st Bicuspid Offset HK	-12	0	3.0	0.81	●	511-184LROFHK 511-184LLOFHK	511-224LROFHK 511-224LLOFHK
2nd Bicuspid	-17	0	3.0	0.81	●	511-185L	511-225L
2nd Bicuspid HK	-17	0	3.0	0.81	●	511-185LRHK 511-185LLHK	511-225LRHK 511-225LLHK
2nd Bicuspid Offset	-17	0	3.0	0.81	●	511-185LOF	511-225LOF
2nd Bicuspid Offset HK	-17	0	3.0	0.81	●	511-185LROFHK 511-185LLOFHK	511-225LROFHK 511-225LLOFHK

Optimal 2x Twin System 10/Pkg.

Phoenix Crystal Clear Twin System



Made in Austria

An innovative new material using medical grade and highly biocompatible copolymers with a small amount of ceramic to increase strength and hardness. It has passed biocompatible tests of skin sensitization, cytotoxicity, oral toxicity and mutagen and no leakage of PBA. The material is 3D printed into each bracket specification with exacting tolerances in all dimensions.



- Textured base bonds and debonds like metal, using your normal adhesives.
- Safe to use. Unlike mono or polycrystalline ceramic brackets, Crystal Clear will not damage opposing enamel and is appropriate for use on the lower arch for maximum aesthetic appearance. Reduced breakage from occlusal forces or during removal, compared to traditional mono or polycrystalline brackets.



- The true twin design at all positions treats as you would with metal twins and sliding mechanics are better than any ceramic.
- The low profile design offers soft curved labial surfaces for the highest degree of patient comfort. They have a very soft feel, unlike any other aesthetic or metal bracket.



- Perfectly clear and incredibly stain resistant throughout normal or extended treatment times.
- Durable in use. Withstands torque application without deformation and outstanding wear resistance.
- Low slot friction for outstanding sliding mechanics.

* These images are showing the textured base as you look down through the bracket. All brackets are clear, as the profile of the last image shows, when bonded to the teeth.



Phoenix Crystal Clear Twin System

Maxillary	Torque	Angulation	Width mm	In/Out mm	ID	.018 Slot	.022 Slot
Central	17	4	3.35	.99	●	502-181UR/17 502-181UL/17	502-221UR/17 502-221UL/17
Central	11	5	3.35	.99	●	502-181UR/11 502-181UL/11	502-221UR/11 502-221UL/11
Lateral	10	8	2.97	1.25	●	502-182UR/10 502-182UL/10	502-222UR/10 502-222UL/10
Lateral	8	9	2.97	1.25	●	502-182UR/8 502-182UL/8	502-222UR/8 502-222UL/8
Cuspid HK	0	8	3.35	.99	●	502-183URHK/OT 502-183ULHK/OT	502-223URHK/OT 502-223ULHK/OT
Bicuspid HK	-7	0	3.35	.99	●	502-184,5URHK 502-184,5ULHK	502-224,5URHK 502-224,5ULHK

Mandibular	Torque	Angulation	Width mm	In/Out mm	ID	.018 Slot	.022 Slot
Anteriors	-6	0	2.87	1.40	● ●	502-181,2/-6	502-221,2/-6
Anteriors	0	0	2.87	1.40	● ●	502-181,2/0	502-221,2/0
Cuspid HK	0	3	3.35	.68	●	502-183LRHK/OT 502-183LLHK/OT	502-223LRHK/OT 502-223LLHK/OT
1st Bicuspid HK	-12	2	3.35	.76	●	502-184LRHK 502-184LLHK	502-224LRHK 502-224LLHK
2nd Bicuspid HK	-17	2	3.35	.76	●	502-185LRHK 502-185LLHK	502-225LRHK 502-225LLHK

5/Pkg.

Made in Austria.

Value Line Twin System



- Features a one-piece design with a bright labial surface and a fine grid pattern base. Bond strength replicates foil mesh, as bracket bases are micro etched.
- Torque in base with rhomboid shape and center scribe lines.
- Cuspids have hooks.
- All bicuspid are plain or have optional hooks.
- Metal injection molded for accurate tolerances and smooth, radiused, comfortable attachments.



Value Line Bondable Brackets & Tubes-Roth*

Maxillary	Color Code	Torque	Angulation	Width mm	.018 Slot	.022 Slot
Central	●	12	5	3.8	515-181UR 515-181UL	515-221UR 515-221UL
Lateral	●	8	9	3.0	515-182UR 515-182UL	515-222UR 515-222UL
Cuspid HK	●	-2	13	3.0	515-183URH 515-183ULH	515-223URH 515-223ULH
Bicuspid	●	-7	0	3.0	515-184,5U	515-224,5U
Bicuspid HK	●	-7	0	3.0	515-184,5URH 515-184,5ULH	515-224,5URH 515-224,5ULH

Mandibular	Color Code	Torque	Angulation	Width mm	.018 Slot	.022 Slot
Central/Lateral	●	0	0	2.5	515-181,2L	515-221,2L
Cuspid HK	●	-11	7	3.0	515-183LRH 515-183LLH	515-223LRH 515-223LLH
1st Bicuspid	○	-17	0	3.0	515-184L	515-224L
1st Bicuspid HK	○	-17	0	3.0	515-184LRH 515-184LLH	515-224LRH 515-224LLH
2nd Bicuspid	●	-22	0	3.0	515-185L	515-225L
2nd Bicuspid HK	●	-22	0	3.0	515-185LRH 515-185LLH	515-225LRH 515-225LLH

10/Pkg.

** The Phoenix version of the Roth Rx is not implied to be an exact version of any other system, nor do we claim any endorsement of Dr. Roth.*

Value Line Bondable Brackets & Tubes-MBT*



Maxillary	Color Code	Torque	Angulation	Width mm	.018 Slot	.022 Slot
Central	●	17	4	3.5	514-181UR 514-181UL	514-221UR 514-221UL
Lateral	●	8	9	2.9	514-182UR 514-182UL	514-222UR 514-222UL
Cuspid HK	●	-7	9	3.2	514-183URH 514-183ULH	514-223URH 514-223ULH
Bicuspid	●	-7	0	3.0	514-184,5U	514-224,5U
Bicuspid HK	●	-7	0	3.0	514-184,5URH 514-184,5ULH	514-224,5URH 514-224,5ULH

Mandibular	Color Code	Torque	Angulation	Width mm	.018 Slot	.022 Slot
Central/Lateral	●	-6	0	2.6	514-181,2L	514-221,2L
Cuspid HK	●	-6	3	3.2	514-183LRH 514-183LLH	514-223LRH 514-223LLH
1st Bicuspid	●	-12 -12	2 2	3.0 3.0	514-184LR 514-184LL	514-224LR 514-224LL
1st Bicuspid HK	●	-12	2	3.0	514-184LRH 514-184LLH	514-224LRH 514-224LLH
2nd Bicuspid	○	-17 -17	2 2	3.0 3.0	514-185LR 514-185LL	514-225LR 514-225LL
2nd Bicuspid HK	○	-17	2	3.0	514-185LRH 514-185LLH	514-225LRH 514-225LLH

10/Pkg.

* The Phoenix version of the McLaughlin, Bennett, Trevisi System is claimed to be a duplication of any other, nor do we imply that it is endorsed in any way by Drs. McLaughlin, Bennett, or Trevisi.

BUCCAL TUBES FOR BONDING AND WELDING



Page 1-2 Optimal 2x Ultra Low Profile Bondable Buccal Tubes

Page 3 Optimal 2x Bondable Convertible Low Profile Buccal Tubes

Page 4 Optimal Mini 2nd Molar Buccal Tubes

Page 5 Mini Bondable 2nd Tubes – Low Friction Tubes – Bondable Auxiliaries

Page 6 Bondable Auxiliaries

Page 7 Convertible Buccal Tubes – Torque in Base

Page 8 Optimal 2x Ultra Low Profile Weldable Buccal Tubes

Page 9 “Original” Series Molar Bands

Page 10 “M” Series Molar Bands

Page 11 Weldable Lingual Attachments

Optimal 2x Ultra Low Profile Bondable Buccal Tubes



NEW OPTIMAL 2X ULTRA LOW PROFILE BUCCAL TUBES FOR FIRST AND SECOND MOLARS offer reduced occlusal interference, provide total control, and increase patient comfort. They complete the Optimal 2x bracket system and can be used to enhance treatment with any torque in base design bracket systems. Metal injection molded (MIM) for strength, accuracy and structural integrity.



Mesial distal scribe lines indicate the height of the arch slot. Recessed round center mark aids in seating the tube while increasing accurate alignment.

Parallel tube surfaces also aid positioning while increasing secure handling during bonding.

Anatomical compound contoured base with pronounced developmental groove for superior fit.

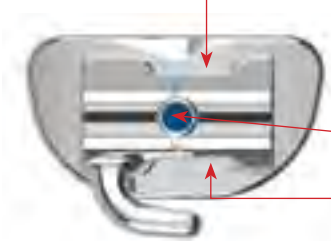

Ample recessed notches assist secure handling with all commonly used instruments.

Recessed round center mark aids in seating the tube while increasing accurate alignment.

Color coded by prescription specification.



Micro etched 80 gauge mesh for maximum bond strength.

Contoured funnel entry for ease of arch wire insertion at any angle.

Bendable hook does not extend beyond the facial plane of the tube body for greater comfort and does not interfere with bonding procedures.



Optimal 2x Ultra Low Profile Bondable Buccal Tubes

OPTIMAL 2x ULTRA LOW PROFILE 1ST MOLARS

	Color Code	Torque	Distal Offset	Quadrant	Bondable .018	Bondable .022
1st Molar 4.2mm tube length 	●	-14	10	UR	800-861 B	800-261 B
	●	-14	10	UL	800-862 B	800-262 B
	●	-20	0	LR	800-857 B	800-257 B
	●	-20	0	LL	800-858 B	800-258 B
	●	0	0	UR/LL	—	800-263 B
	●	0	0	UL/LR	—	800-264 B
	●	-10	0	UR/LL	800-865 B	800-265 B
	●	-10	0	UL/LR	800-866 B	800-266 B

OPTIMAL 2x ULTRA LOW PROFILE 2ND MOLARS

	Color Code	Torque	Distal Offset	Quadrant	Bondable .018	Bondable .022
2nd Molar 3.2mm tube length 	●	-14	10	UR	800-835 B	800-235 B
	●	-14	10	UL	800-836 B	800-236 B
	●	-20	0	LR/UL	800-867 B	800-267 B
	●	-20	0	LL/UR	800-868 B	800-268 B
	●	0	0	UR/LL	—	800-269 B
	●	0	0	UL/LR	—	800-270 B
	●	-10	0	UR/LL	800-855 B	800-255 B
	●	-10	0	UL/LR	800-856 B	800-256 B

10/Pkg.

Optimal 2x Bondable Convertible Low Profile Buccal Tubes



Optimal 2x Convertible Low Profile Buccal Tubes achieve stronger, more consistent bonds. Features a low profile design to reduce occlusal interference, provide greater patient comfort, and enhance hygiene.

Convertible caps are molded as an integral part of the tube. This solid one-piece construction provides a cap that converts easily and consistently. Eliminates any pre-mature conversion and any possibility of braze or solder material residue in the arch wire slot. Converts when you are ready by lift and peel with a Weingardt.



- Metal injection molded (MIM) stainless steel for strength, accuracy and structural integrity
- Full rotational control provided by the 4.2 mm length of tube
- Color coded by prescription and quadrant



- Funneled arch wire entry point for ease of wire insertion
- Torque in base for functional occlusion and finishing
- Adjustable low profile hook increases comfort



- 80 gauge micro etched bases increase bond shear strength by up to 35% compared to the same non-etched bases
- Compound contoured (6.6 mm x 3.0 mm) base
- Buccal indent naturally conforms to the molar surface, making positioning easier

	Color Code	Torque	Distal Offset	Quadrant	Bondable .018	Bondable .022
Maxillary 1st Molar	●	-14	10	UR	800-837 B	800-237 B
	●	-14	10	UL	800-838 B	800-238 B
Mandibular 1st Molar	○	-20	0	LR	800-845 B	800-245 B
	○	-20	0	LL	800-846 B	800-246 B
	●	-25	5	LR	800-821 B	800-221 B
	●	-25	5	LL	800-822 B	800-222 B

10/Pkg.



Optimal Mini 2nd Molar Buccal Tubes

OPTIMAL MINI 2ND MOLARS



- Diagonal foil mesh for increased bond strength



- Funneled slot entry point for ease of arch wire insertion at any angle
- Recessed center of tube mark indicates slot height and aids in seating during bonding





- Small 2.5 mm tubes on curved 4.2 x 2.5 mm bases
- Adapted to fit on mesial buccal cusps of partially erupted molars

Mini 2nd Molar	Color Code	Torque	Distal Offset	Quadrant	Bondable .018	Bondable .022
Maxillary/Mandibular 2nd	●	-10	0	UL/LR	801-873 B	801-273 B
	●	-10	0	UR/LL	801-874 B	801-274 B
Maxillary/Mandibular 2nd	●	-25	0	LR/UL	801-871 B	801-271 B
	●	-25	0	LL/UR	801-872 B	801-272 B

10/Pkg. Bondable

Mini Bondable 2nd Tubes – Low Friction Tubes – Bondable Auxiliaries

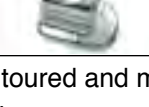

		Torque	Distal Offset	Quadrant	Bondable .018 Slot	Bondable .022 Slot
Mini 2nd Molar – partially erupted						
Maxillary/Mandibular 2nd		-10	0	UR/LL	817-831 B	817-231 B
Maxillary/Mandibular 2nd		-10	0	UL/LR	817-832 B	817-232 B
Mandibular 2nd		-25	0	LR	817-833 B	817-233 B
Mandibular 2nd		-25	0	LL	817-834 B	817-234 B

- 2.2 mm tube on a 3.5 mm contoured and mesially extended pad
- Recessed arch wire entry point
- Buccal divot to aid in final positioning and seating
- Micro etched bases

10/Pkg.

Product	Description	Item #	Quantity
Low Friction Tube			



- 0.36 I.D. x 1.5 mm tube on a 4.0 x 2.5 mm base
- Assist slow erupting bicuspid
- Pull down high cuspids
- Lift angled second molars

497-T
Curved Base

497-T-F
Flat Base

10/Pkg.

10/Pkg.

Extrusion Hook/Eyelet



- Placed gingivally on cuspids and use with .014 SE/NT to extrude
- Tie with thread

407

10/Pkg.

Coil



- 3.6 mm flat base
- 3.0 mm tall loop perpendicular to base
- 050 I.D. loop diameter

513

10/Pkg.

Extrusion Coil with Chain



- Extrude gingivally impacted cuspids
- Open mesh for good adhesive flow, 3.9 mm diameter
- 1" 10K gold chain accepts threads through .030.

408

1/Pkg.

Habit Corrector (Tongue Spur)











- Bond to either arch
- Discourages mesial tongue activity
- Curved 80 gauge mesh base

711-THC

10/Pkg.











Bondable Auxiliaries

Product	Description	Item #	Quantity
Round Composite Button			
	<ul style="list-style-type: none"> • 3.3 mm fits where you need it • Comfortable – accepts 6 oz elastics 	504-RB	10/Pkg.
Rectangular Composite Button			
	<ul style="list-style-type: none"> • 2.8 x 2.0 mm size • Accepts all elastics 	504-B	10/Pkg.
Eyelet, Composite			
	<ul style="list-style-type: none"> • 2.75 mm with .033 I.D. • Bring down high cuspids with thread or 012/014 NT wire • Affect rotations 	504-E	10/Pkg.
Bite Opening Composite Ramp			
	<ul style="list-style-type: none"> • 5 mm height opens bite immediately • More comfortable than S.S. and will not wear enamel 	710-BR	10/Pkg.
Button, Ovoid Curved Mesh Base			
	<ul style="list-style-type: none"> • 4.3 x 2 mm fits molars and bicuspid 	490-OV	10/Pkg.
Button, Rectangular Curved Base			
	<ul style="list-style-type: none"> • 4.0 x 2.6 mm fits molars and bicuspid 	490-C	20/Pkg.
Button, Round Curved Base			
	<ul style="list-style-type: none"> • 3.9 mm 	491-C	10/Pkg.
Button, Round			
	<ul style="list-style-type: none"> • 3.5 mm 	491	10/Pkg.

Convertible Buccal Tubes – Torque in Base



	Torque	Distal Offset	Round Tube	Quadrant	Weldable		Bondable		
					.018 Slot	.022 Slot	.018 Slot	.022 Slot	
Maxillary 1st Molar									
Triple¹ <i>(Occlusal Headgear Tube)</i> <i>(.018x .025 auxiliary tube is 0 degree torque)</i> 	-10	8	.045	R	800-805	800-205			
	-10	8	.045	L	800-806	800-206			
	-14	10	.045	R	800-809	800-209			
	-14	10	.045	L	800-810	800-210			
Combination² <i>(Occlusal Headgear Tube)</i> 	-10	8	.045	R	800-803	800-203			
	-10	8	.045	L	800-804	800-204			
	-14	10	.045	R	800-811	800-211			
	-14	10	.045	L	800-812	800-212			
Combination¹ <i>(Gingival Headgear Tube)</i> 	-10	8	.045	R	800-801	800-201			
	-10	8	.045	L	800-802	800-202			
	-14	10	.045	R	800-827	800-227			
	-14	10	.045	L	800-828	800-228			
Double Arch Slot¹ <i>(.018 x .025 auxiliary tube is 0 degree torque)</i> 	-10	8	0	R	800-817	800-217			
	-10	8	0	L	800-818	800-218			
Single-Low Profile² 	-10	8	0	R	800-807	800-207			
	-10	8	0	L	800-808	800-208			
	-14	10	0	R	800-837	800-237	800-837 B	800-237 B	
	-14	10	0	L	800-838	800-238	800-838 B	800-238 B	
Mandibular 1st Molar									
Single-Low Profile² 	-25	5	0	R	800-821	800-221			
	-25	5	0	L	800-822	800-222			
	-20	0	0	R	800-845	800-245	800-845 B	800-245 B	
	-20	0	0	L	800-846	800-246	800-846 B	800-246 B	
Double¹ <i>(.018 x .025 auxiliary tube is 0 degree torque)</i> 	-25	5	0	R	800-823	800-223			
	-25	5	0	L	800-824	800-224			
	-20	0	0	R	800-825	800-225			
	-20	0	0	L	800-826	800-226			
Lip Bumper¹ 	-25	5	.045	R	800-843	800-243			
	-25	5	.045	L	800-844	800-244			

¹ Tube is 3.5 mm long
² Tube is 4.2 mm long

All bondable buccal tubes above are on this base.
 10/Pkg.



6.6 mm x 3.0 mm



Optimal 2x Ultra Low Profile Weldable Buccal Tubes

1st Molars

	Color Code	Torque	Distal Offset	Quadrant	Weldable .018	Weldable .022
1st Molar 4.2mm tube length 	●	-14	10	UR	800-861	800-261
	●	-14	10	UL	800-862	800-262
	●	-20	0	LR	800-857	800-257
	●	-20	0	LL	800-858	800-258
	●	-10	0	UR/LL	800-865	800-265
	●	-10	0	UL/LR	800-866	800-266

2nd Molars

	Color Code	Torque	Distal Offset	Quadrant	Weldable .018	Weldable .022
2nd Molar 3.2mm tube length 	●	-14	10	UR	800-835	800-235
	●	-14	10	UL	800-836	800-236
	●	-20	0	LR/UL	800-867	800-267
	●	-20	0	LL/UR	800-868	800-268
	●	-10	0	UR/LL	800-855	800-255
	●	-10	0	UL/LR	800-856	800-256

“Original” Series – Anatomical Molar Bands



Maxillary 1st & 2nd Molar Bands

- “Original” Series molar bands anatomically conform to the individual tooth.
- Available in 36 proportionally graduated sizes.
- A buccal/cusp indent eliminates occlusal interference.
- Permanent markings on the mesial surface clearly identifies the size and quadrant.
- All kits contain 1/2 right and 1/2 left.
- Micro etched inner surfaces increases adhesive strength.



<i>Distribution of Sizes per Tooth</i>																																						
<i>Catalog No./Type</i>	1	2	3	4	5	6	7	8	9	10	11	12	13	14	15	16	17	18	19	20	21	22	23	24	25	26	27	28	29	30	31	32	33	34	35	36		
<i>K12-UP-TRIAL (80)</i>	-	-	-	-	-	2	2	4	4	4	6	6	10	10	10	6	6	4	4	2	-	-	-	-	-	-	-	-	-	-	-	-	-	-	-	-	-	-
<i>K12-UP-INTRO (158)</i>	2	2	2	2	2	2	4	4	6	8	8	10	10	10	12	10	10	8	6	4	4	4	2	2	2	2	2	2	2	2	2	2	2	2	2	2	2	
<i>K12-UP-PRO (316)</i>	4	4	4	4	4	4	8	8	12	16	16	20	20	20	24	20	20	16	12	8	8	8	4	4	4	4	4	4	4	4	4	4	4	4	4	4	4	4
<i>K12-UP-MASTER (648)</i>	8	8	8	8	8	8	16	16	24	32	32	40	40	40	48	40	40	32	24	16	16	16	8	8	8	8	8	8	8	8	8	8	8	8	8	8	8	8

Mandibular 1st Molar Bands

- “Original” Series molar bands anatomically conform to the individual tooth.
- Available in 36 proportionally graduated sizes.
- Two buccal/cusp indents and a lingual indent provide ideal conformity.
- Permanent markings on the mesial surface clearly identifies the size and quadrant.
- All kits contain 1/2 right and 1/2 left.
- Micro etched inner surfaces increases adhesive strength.



<i>Distribution of Sizes per Tooth</i>																																						
<i>Catalog No./Type</i>	1	2	3	4	5	6	7	8	9	10	11	12	13	14	15	16	17	18	19	20	21	22	23	24	25	26	27	28	29	30	31	32	33	34	35	36		
<i>K12-LO-TRIAL (80)</i>	-	-	-	-	-	2	2	4	4	4	6	6	10	10	10	6	6	4	4	2	-	-	-	-	-	-	-	-	-	-	-	-	-	-	-	-	-	-
<i>K12-LO-INTRO (158)</i>	2	2	2	2	2	2	4	4	6	8	8	10	10	10	12	10	10	8	6	4	4	4	2	2	2	2	2	2	2	2	2	2	2	2	2	2	2	2
<i>K12-LO-PRO (316)</i>	4	4	4	4	4	4	8	8	12	16	16	20	20	20	24	20	20	16	12	8	8	8	4	4	4	4	4	4	4	4	4	4	4	4	4	4	4	4
<i>K12-LO-MASTER (648)</i>	8	8	8	8	8	8	16	16	24	32	32	40	40	40	48	40	40	32	24	16	16	16	8	8	8	8	8	8	8	8	8	8	8	8	8	8	8	8

Mandibular 2nd Molar Bands

- “Original” Series molar bands anatomically conform to the individual tooth.
- Available in 36 proportionally graduated sizes.
- A lingual indent allows for a precise fit and eliminates occlusal interference.
- Permanent markings on the mesial surface clearly identifies the size and quadrant.
- All kits contain 1/2 right and 1/2 left.
- Micro etched inner surfaces increases adhesive strength.



<i>Distribution of Sizes per Tooth</i>																																						
<i>Catalog No./Type</i>	1	2	3	4	5	6	7	8	9	10	11	12	13	14	15	16	17	18	19	20	21	22	23	24	25	26	27	28	29	30	31	32	33	34	35	36		
<i>K13-LO-TRIAL (80)</i>	-	-	-	-	-	2	2	4	4	4	6	6	10	10	10	6	6	4	4	2	-	-	-	-	-	-	-	-	-	-	-	-	-	-	-	-	-	-
<i>K13-LO-INTRO (158)</i>	2	2	2	2	2	2	4	4	6	8	8	10	10	10	12	10	10	8	6	4	4	4	2	2	2	2	2	2	2	2	2	2	2	2	2	2	2	2
<i>K13-LO-PRO (316)</i>	4	4	4	4	4	4	8	8	12	16	16	20	20	20	24	20	20	16	12	8	8	8	4	4	4	4	4	4	4	4	4	4	4	4	4	4	4	4
<i>K13-LO-MASTER (648)</i>	8	8	8	8	8	8	16	16	24	32	32	40	40	40	48	40	40	32	24	16	16	16	8	8	8	8	8	8	8	8	8	8	8	8	8	8	8	8



"M" Series – Anatomical Molar Bands

Maxillary 1st & 2nd Molar Bands

- "M" Series molar bands anatomically conform to the individual tooth.
- Available in 30 proportionally graduated half sizes assures a custom fit.
- A buccal/cusp indent eliminates occlusal interference.
- Permanent markings on the mesial surface clearly identifies the size and quadrant.
- All kits contain 1/2 right and 1/2 left.
- Micro etched inner surfaces increases adhesive strength.



<i>Distribution of Sizes per Tooth</i>																														
<i>Catalog No./Type</i>	29½	30	30½	31	31½	32	32½	33	33½	34	34½	35	35½	36	36½	37	37½	38	38½	39	39½	40	40½	41	41½	42	42½	43	43½	44
<i>K10-UP-TRIAL (80)</i>	-	-	-	-	-	2	2	4	4	4	6	6	10	10	10	6	6	4	4	2	-	-	-	-	-	-	-	-	-	-
<i>K10-UP-INTRO (150)</i>	2	2	2	2	2	4	4	6	8	10	10	10	10	12	12	10	8	6	4	4	4	2	2	2	2	2	2	2	2	
<i>K10-UP-PRO (300)</i>	4	4	4	4	4	8	8	12	16	20	20	20	20	24	24	20	16	12	8	8	8	4	4	4	4	4	4	4	4	
<i>K10-UP-MASTER (600)</i>	8	8	8	8	8	16	16	24	32	40	40	40	40	48	48	40	32	24	16	16	16	8	8	8	8	8	8	8	8	

Mandibular 1st Molar Bands

- "M" Series molar bands anatomically conform to the individual tooth.
- Available in 30 proportionally graduated half sizes assures a custom fit.
- Two buccal/cusp indents and a lingual indent provide ideal conformity.
- Permanent markings on the mesial surface clearly identifies the size and quadrant.
- All kits contain 1/2 right and 1/2 left.
- Micro etched inner surfaces increases adhesive strength.



<i>Distribution of Sizes per Tooth</i>																														
<i>Catalog No./Type</i>	29½	30	30½	31	31½	32	32½	33	33½	34	34½	35	35½	36	36½	37	37½	38	38½	39	39½	40	40½	41	41½	42	42½	43	43½	44
<i>K10-LO-TRIAL (80)</i>	-	-	-	-	-	2	2	4	4	4	6	6	10	10	10	6	6	4	4	2	-	-	-	-	-	-	-	-	-	
<i>K10-LO-INTRO (150)</i>	2	2	2	2	2	4	4	6	8	10	10	10	10	12	12	10	8	6	4	4	4	2	2	2	2	2	2	2	2	
<i>K10-LO-PRO (300)</i>	4	4	4	4	4	8	8	12	16	20	20	20	20	24	24	20	16	12	8	8	8	4	4	4	4	4	4	4	4	
<i>K10-LO-MASTER (600)</i>	8	8	8	8	8	16	16	24	32	40	40	40	40	48	48	40	32	24	16	16	16	8	8	8	8	8	8	8	8	

Mandibular 2nd Molar Bands

- "M" Series molar bands anatomically conform to the individual tooth.
- Available in 27 proportionally graduated half sizes assures a custom fit.
- A lingual indent allows for a precise fit and eliminates occlusal interference.
- Permanent markings on the mesial surface clearly identifies the size and quadrant.
- All kits contain 1/2 right and 1/2 left.
- Micro etched inner surfaces increases adhesive strength.



<i>Distribution of Sizes per Tooth</i>																											
<i>Catalog No./Type</i>	29½	30	30½	31	31½	32	32½	33	33½	34	34½	35	35½	36	36½	37	37½	38	38½	39	39½	40	40½	41	41½	42	42½
<i>K11-LO-TRIAL (80)</i>	-	-	-	-	-	2	2	4	4	4	6	6	10	10	10	6	6	4	4	2	-	-	-	-	-	-	-
<i>K11-LO-INTRO (150)</i>	2	2	2	2	2	4	6	8	8	10	10	10	10	12	12	10	8	8	6	4	4	2	2	2	2	2	
<i>K11-LO-PRO (300)</i>	4	4	4	4	6	8	8	8	12	14	16	18	20	24	24	24	20	18	16	12	10	6	6	6	4	4	
<i>K11-LO-MASTER (600)</i>	8	8	8	8	12	16	18	22	26	32	40	40	48	48	48	40	36	30	24	20	16	12	12	12	8	8	

Weldable Lingual Attachments



Cleats *Provided loose and tumbled to smooth corners.*

Product	Style	Length	Weldable	Pkg.
	Large	8.1 mm	829-025	1/Pkg.



Buttons – Weldable *The one piece design and domed head allows for maximum patient comfort.*

Product	Style	Weldable	Pkg.
	Semi-Flat	829-024	1/Pkg.

Seating Lugs – Weldable – on strips

Product	Style	Length	Weldable	Pkg.
	Universal	3.8 mm	829-028	1/Pkg.

Sheath – Weldable

Product	Style	Wire Size Doubled	Universal	Weldable	Pkg.
	Window w/indent	.036	U	829-029	1/Pkg.
	Window w/indent & ball hook mesial	.036	UR/LL	829-030	1/Pkg.
		.036	UL/LR	829-031	1/Pkg.

ARCH WIRES

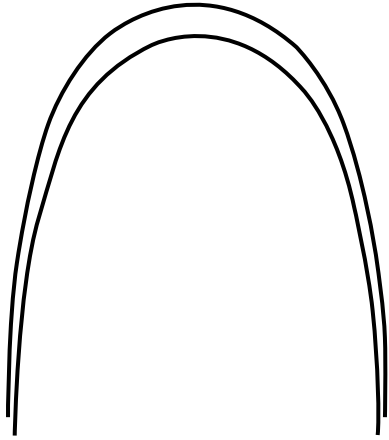

Page 1-4 Arch Forms

Page 5-6 Arch Wire Alloys and Forces

Page 7-8 Trans Thermal Heat Activated Nickel Titanium

Page 9-10 SE Nickel Titanium

Page 11-12 Pro Force Nickel Titanium

Page 13-14 Molybdenum Titanium Alloy – MTA

Page 15-16 Stainless Steel Resilient

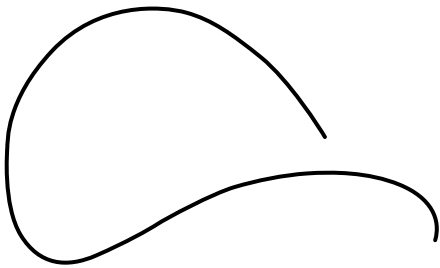
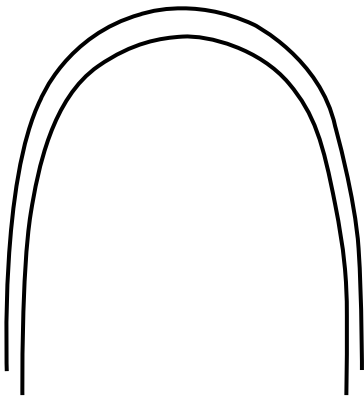



The search for the ideal arch form can be documented in research and articles dating back over one hundred years and you could reasonably conclude there is no one form suitable for all patients. Relapse occurs frequently during long term retention when the arch form has been changed greatly from what the patient initially presents. This suggests that a variety of arch forms should be employed. These forms should offer shape assortment as well as varying inter-canine and inter-molar widths.

You could objectively make a case that there are three principal shapes that occur most often: **Square** or **Broad**, **Ovoid**, and **Tapered**.

Ideally each wire should be custom contoured for each patient and that is easily done in stainless steel and MTA. All types of nickel titanium alloys do not allow this, so Phoenix offers a full range of wire alloys and forces in each form that we offer. Also note that in each form the maxillary arch follows the shape of the lower arch and is 3 to 4 mm larger to provide arch wire coordination in the majority of cases.

Symmetry iP, ideal proportion arch wires, now offers three sizes of the same ovoid shape. This gives the clinician the option of larger or smaller combinations of arches as measured by inter-canine and inter-molar widths.



Square or Broad arches such as the Symmetry form that offers the most width at the canines and in the posterior.
New "Small" lower now offers a combination of cuspid and molar widths.

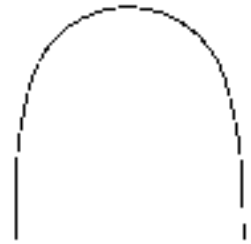

Ovoid arches like Symmetry II and Symmetry III Small that offer less cuspid widths and various amounts of posterior width.

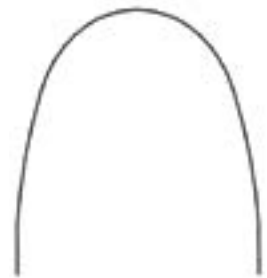

Ovoid arches like Symmetry iP offering combinations of cuspid and molar widths.

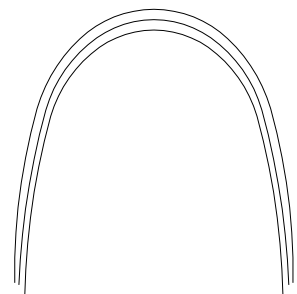

Tapered arches such as Symmetry IV Tapered.

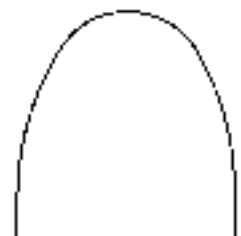



Available alloys and forces are listed in each form

SYMMETRY

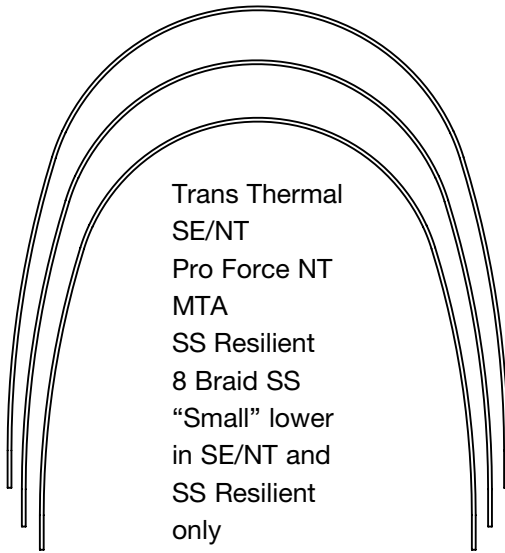

SYMMETRY II

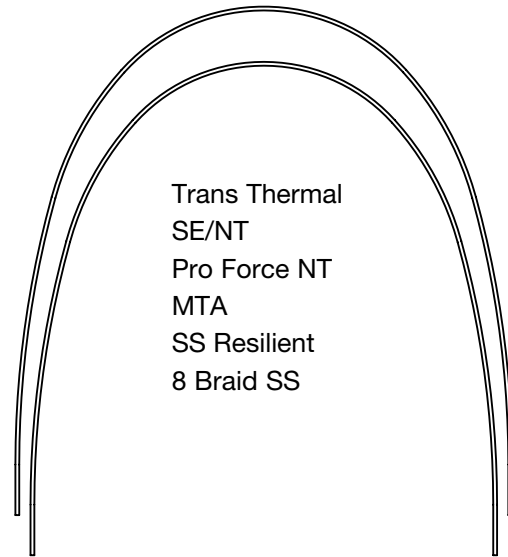

SYMMETRY III SMALL

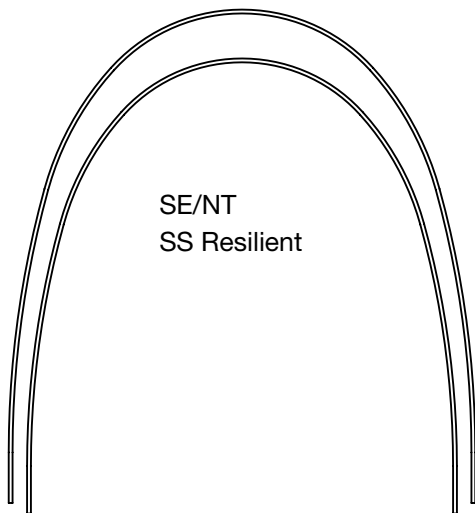

SYMMETRY IV TAPERED

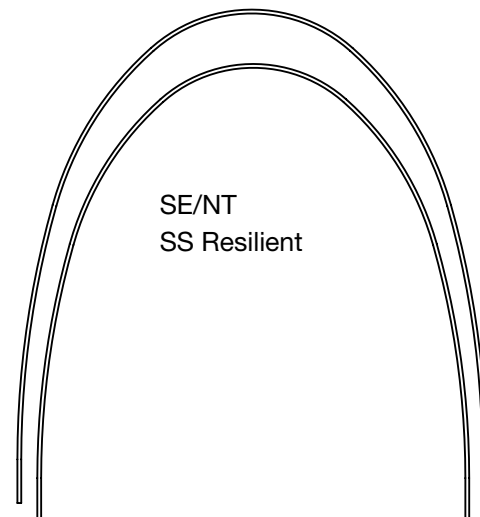



Symmetry iP now gives the clinician the option of two inter-canine and inter-molar widths in all types of alloys and forces. This allows for more customization for each patient in arch wire alloys that cannot be re-contoured.

The ovoid shapes also provide for an aesthetically finished smile without the dark areas associated with broad or square shapes.

Symmetry *iP*
ideal proportion archwires

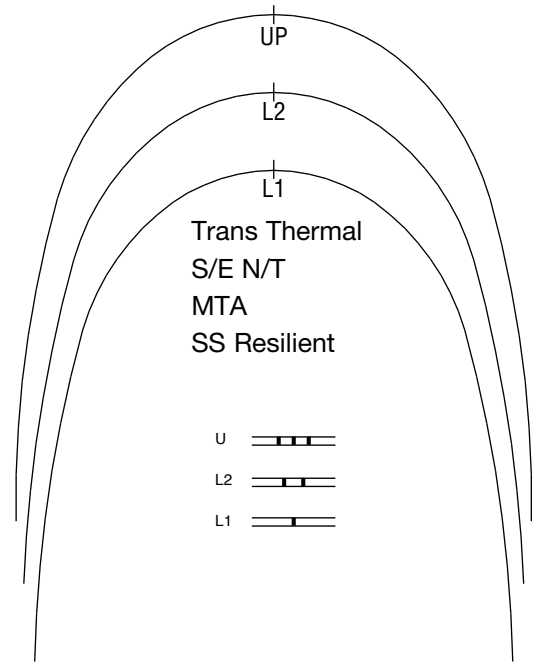

©PHOENIX ORTHODONTICS INCORPORATED, USA
All Rights Reserved 2016

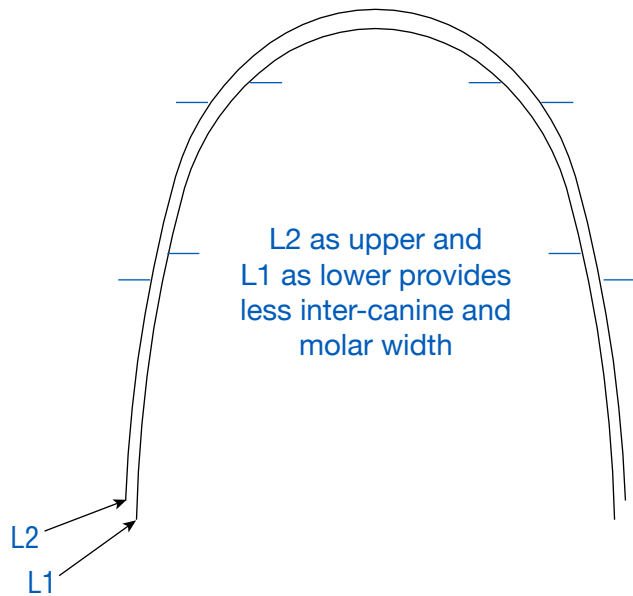

L2 as upper and L1 as lower provides less inter-canine and molar width

L2
L1

Etched Midlines

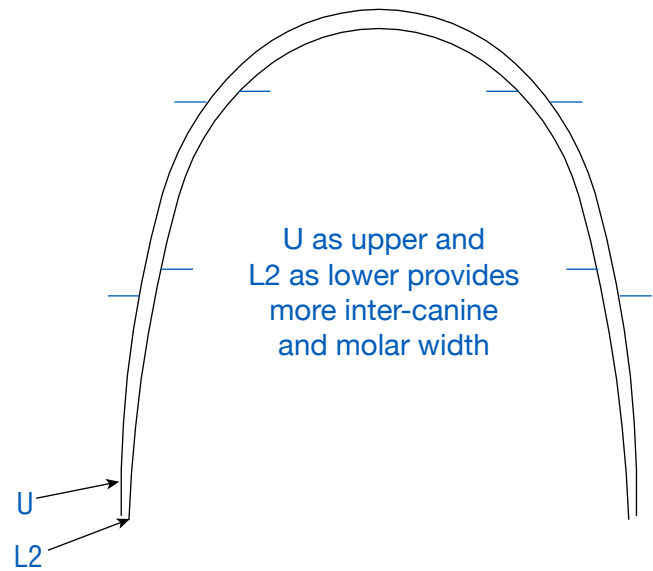

U as upper and L2 as lower provides more inter-canine and molar width

U
L2

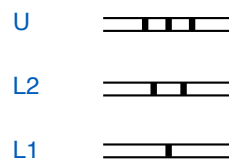

Arch Wire Alloys and Forces



Trans Thermal Heat Activated Nickel Titanium

- Light continuous forces are fully active at 95 degrees F.
- Round wires easily engage in the most severely misaligned teeth.
- Square and rectangular wires can be employed earlier in treatment for torque control in all bracket systems and especially for ceramics.
- Easy ligation at room temperatures or when chilled and complete shape memory at body temperature.

SE Nickel Titanium

- Light continuous forces at a range between Trans Thermal Heat Activated and Pro Force Nickel Titanium allows for easy engagement.
- Near constant unloading (tooth moving) forces regardless of the degree of deflection.
- Superior smooth and bright finish for reduced friction.

Pro Force Nickel Titanium

- Progressive loading and unloading forces in a moderate range that can increase efficiency and require fewer arch wire changes. The higher the degree of deflection, the greater the return or tooth moving forces.
- Highly effective in space closure/retractions, stubborn rotations, leveling and arch form development.
- Rectangular dimensions are excellent finishing wires where complete torque control is required. Detailing in the vertical and horizontal planes is accomplished with our narrow tip three prong plier.
- Our Original nickel titanium wire that delivers the force when you need it.
- Superior smooth and bright finish for reduced friction.

Molybdenum Titanium Alloy – MTA

- This special alloy provides forces midway between Pro Force Nickel Titanium and Stainless Steel while offering some memory benefit like nickel titanium and the bendability of stainless steel.
- The ideal retraction loop wire and the smooth finish reduces friction.
- Careful processing of this alloy has effectively eliminated breakage.
- Excellent torque control because of tight corner radii and cross sectional diagonal specifications.
- Long distal lengths of these arches allow for multiple loops and detailing while allowing treatment of second molars if desired.

Stainless Steel

- The highest quality 304V alloys are used to produce superior tensile strength with less brittleness that could cause breakage.
- Tight torque control at less than the industry allowable standard of up to three degrees.
- Resilient Stainless Steel offers an ultra smooth bright mirror finish.
- Resilient Plus is a heat treated, stress relieved, goldtone finish with slightly higher spring and stiffness than Resilient.

Arch Wire packaging and labeling is color matched to catalog descriptions.



Arch Wire Alloys and Forces

Trans Thermal Nickel Titanium

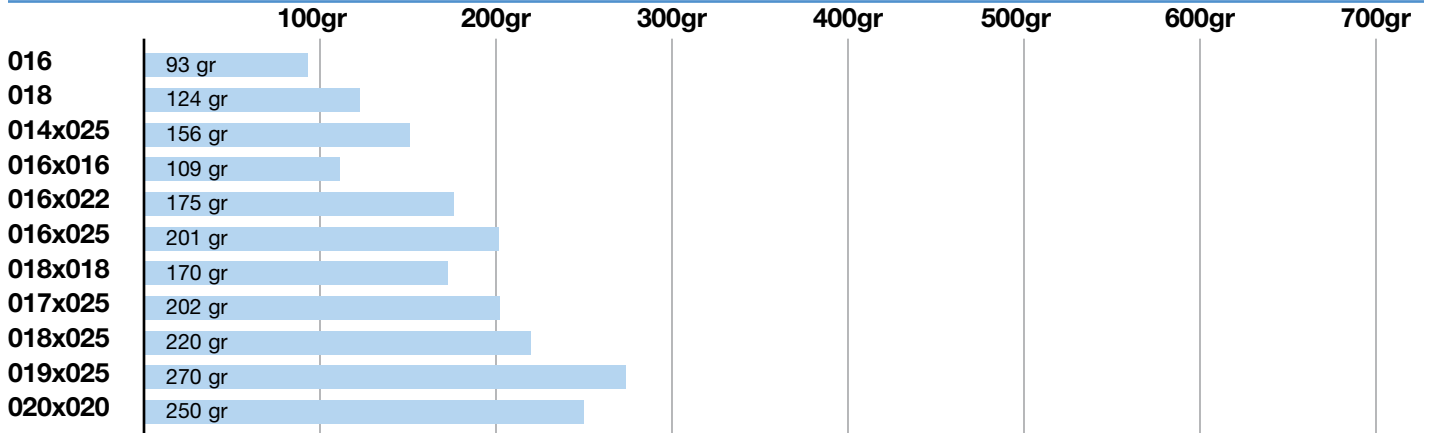

SE Nickel Titanium

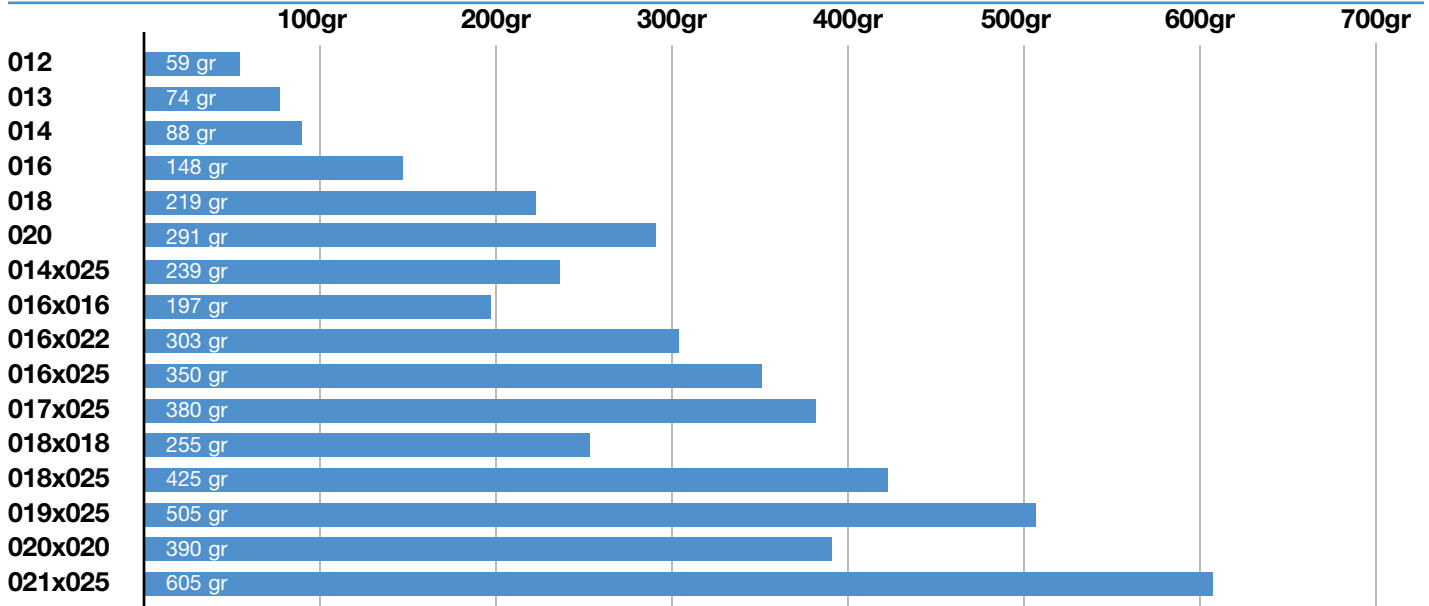

Pro Force Nickel Titanium

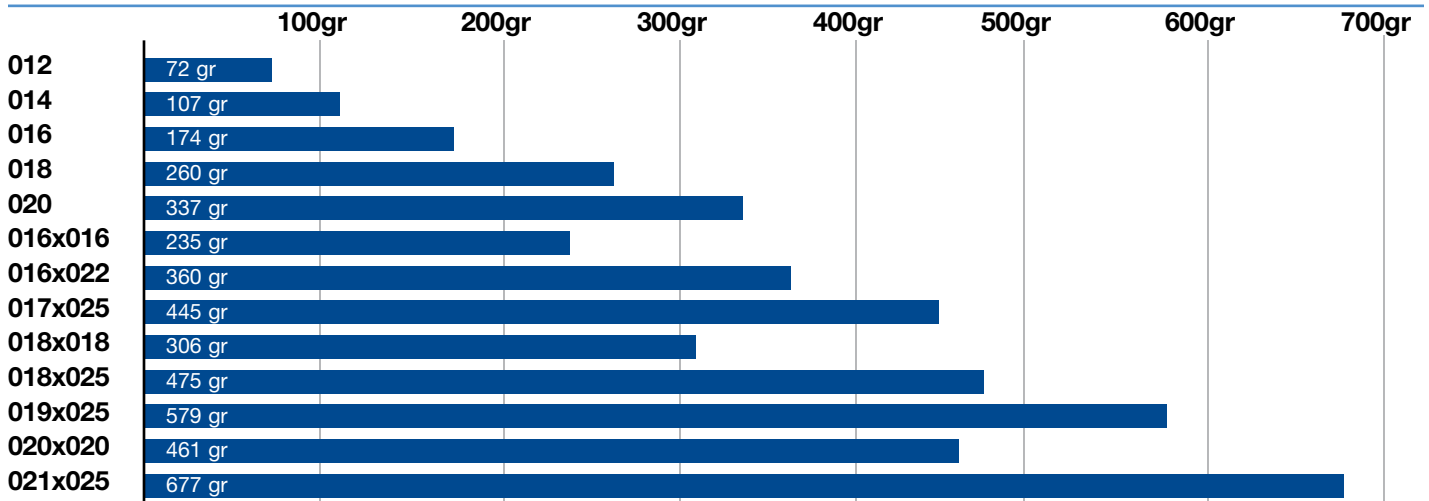

Testing Method: ANSI ADA Spec. #32, 3.1 mm deflection over a 10 mm span.

Data Capture: Unloading forces in grams at 2 mm deflection in vertical plane, rounded to nearest gram.

Sampling: Average of 10 random production lots.

Load Cell: 50 N (5098 grams) with .001 grams accuracy.

To Place Orders: 800-735-6029 • Atlanta area 770-643-8896 • Fax 770-643-1974

orders@phoenixortho.com • www.phoenixorthodonticsgeorgia.com

Trans Thermal Heat Activated Nickel Titanium



DIAMETERS	SYMMETRY	SYMMETRY II
016U	212-16U	216-16U
016L	212-16L	216-16L
018U	212-18U	216-18U
018L	212-18L	216-18L
020U	—	—
020L	—	—
014x025U	212-14x25U	—
014X025L	212-14x25L	—
016x016U	212-16x16U	216-16x16U
016x016L	212-16x16L	216-16x16L
016x022U	212-16x22U	216-16x22U
016x022L	212-16x22L	216-16x22L
016x025U	212-16x25U	—
016x025L	212-16x25L	—
017x025U	212-17x25U	216-17x25U
017x025L	212-17x25L	216-17x25L
018x018U	—	—
018x018L	—	—
018x025U	212-18x25U	216-18x25U
018x025L	212-18x25L	216-18x25L
019x025U	212-19x25U	216-19x25U
019x025L	212-19x25L	216-19x25L
020x020U	—	—
020x020L	—	—
021x025U	212-21x25U	216-21x25U
021x025L	212-21x25L	216-21x25L



Trans Thermal Heat Activated Nickel Titanium

Wire Size	Trans Thermal
013U	—
014U	—
016U	249-16U
018U	249-18U
020U	—
014x025U	249-14x25U
016x022U	249-16x22U
016x025U	249-16x25U
017x025U	249-17x25U
018x025U	249-18x25U
019x025U	249-19x25U
018x018U	249-18x18U
020x020U	249-20x20U
013L2	—
014L2	—
016L2	249-16L2
018L2	249-18L2
020L2	—
014x025L2	249-14x25L2
016x022L2	249-16x22L2
016x025L2	249-16x25L2
017x025L2	249-17x25L2
018x025L2	249-18x25L2
019x025L2	249-19x25L2
018x018L2	249-18x18L2
020x020L2	249-20x20L2
013L1	—
014L1	—
016L1	249-16L1
018L1	249-18L1
020L1	—
014x025L1	249-14x25L1
016x022L1	249-16x22L1
016x025L1	249-16x25L1
017x025L1	249-17x25L1
018x025L1	249-18x25L1
019x025L1	249-19x25L1
018x018L1	249-18x18L1
020x020L1	249-20x20L1

Center Stop Not Available

Light continuous forces

Fully active at 95°F with complete shape memory

Round wires engage easily in the most severe malocclusions

Square and rectangular wires can be employed earlier in treatment

10/Pkg.

Etched midline marks

3 upper
1 lower

* Add CS to part number to receive no drift center stop feature.
Example: 212CS – 16x22U is Symmetry form with center stop size 016x022 upper

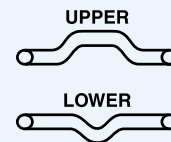

Applies to page 3-7

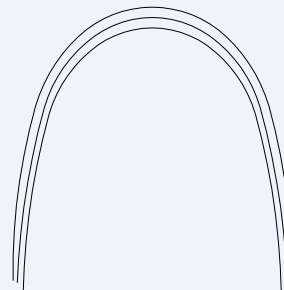

Symmetry *IP*
Etched Midlines



A Proprietary & Premium Product

Exclusively Phoenix-USA

SE Nickel Titanium



DIAMETERS	SYMMETRY*	SYMMETRY SMALL	SYMMETRY II*	SYMMETRY III SMALL	SYMMETRY IV TAPERED	ORIGINAL RCS ⁽¹⁾
012U	205-12U	—	206-12U	234-12U	235-12U	—
012L	205-12L	—	206-12L	234-12L	235-12L	—
014U	205-14U	—	206-14U	234-14U	235-14U	236-14U
014L	205-14L	205SM-14L	206-14L	234-14L	235-14L	236-14L
016U	205-16U	—	206-16U	234-16U	235-16U	236-16U
016L	205-16L	205SM-16L	206-16L	234-16L	235-16L	236-16L
018U	205-18U	—	206-18U	234-18U	235-18U	236-18U
018L	205-18L	205SM-18L	206-18L	234-18L	235-18L	236-18L
020U	205-20U	—	206-20U	234-20U	235-20U	236-20U
020L	205-20L	205SM-20L	206-20L	234-20L	235-20L	236-20L
014x025U	205-14x25U	—	206-14x25U	—	—	—
014x025L	205-14x25L	—	206-14x25L	—	—	—
016x016U	205-16x16U	—	206-16x16U	234-16x16U	235-16x16U	236-16x16U
016x016L	205-16x16L	—	206-16x16L	234-16x16L	235-16x16L	236-16x16L
016x022U	205-16x22U	—	206-16x22U	234-16x22U	235-16x22U	236-16x22U
016x022L	205-16x22L	205SM-16x22L	206-16x22L	234-16x22L	235-16x22L	236-16x22L
016x025U	205-16x25U	—	206-16x25U	—	—	—
016x025L	205-16x25L	—	206-16x25L	—	—	—
017x025U	205-17x25U	—	206-17x25U	234-17x25U	235-17x25U	236-17x25U
017x025L	205-17x25L	205SM-17x25L	206-17x25L	234-17x25L	235-17x25L	236-17x25L
018x018U	205-18x18U	—	206-18x18U	—	—	—
018x018L	205-18x18L	—	206-18x18L	—	—	—
018x025U	205-18x25U	—	206-18x25U	234-18x25U	235-18x25U	236-18x25U
018x025L	205-18x25L	205SM-18x25L	206-18x25L	234-18x25L	235-18x25L	236-18x25L
019x025U	205-19x25U	—	206-19x25U	234-19x25U	235-19x25U	236-19x25U
019x025L	205-19x25L	205SM-19x25L	206-19x25L	234-19x25L	235-19x25L	236-19x25L
020x020U	205-20x20U	—	206-20x20U	—	—	—
020x020L	205-20x20L	—	206-20x20L	—	—	—
021x025U	205-21x25U	—	206-21x25U	234-21x25U	—	—
021x025L	205-21x25L	—	206-21x25L	234-21x25L	—	—

**Center Stop
Not Available**

**Center Stop
Not Available**

**Center Stop
Not Available**



Wire Size	SE Nickel Titanium
013U	245-13U
014U	245-14U
016U	245-16U
018U	245-18U
020U	245-20U
014x025U	245-14x25U
016x022U	245-16x22U
016x025U	245-16x25U
017x025U	245-17x25U
018x025U	245-18x25U
019x025U	245-19x25U
018x018U	245-18x18U
020x020U	245-20x20U
013L2	245-13L2
014L2	245-14L2
016L2	245-16L2
018L2	245-18L2
020L2	245-20L2
014x025L2	245-14x25L2
016x022L2	245-16x22L2
016x025L2	245-16x25L2
017x025L2	245-17x25L2
018x025L2	245-18x25L2
019x025L2	245-19x25L2
018x018L2	245-18x18L2
020x020L2	245-20x20L2
013L1	245-13L1
014L1	245-14L1
016L1	245-16L1
018L1	245-18L1
020L1	245-20L1
014x025L1	245-14x25L1
016x022L1	245-16x22L1
016x025L1	245-16x25L1
017x025L1	245-17x25L1
018x025L1	245-18x25L1
019x025L1	245-19x25L1
018x018L1	245-18x18L1
020x020L1	245-20x20L1

Center Stop Not Available

SE Nickel Titanium

Light continuous forces at a range between Trans Thermal and Pro Force Nickel Titanium allows for easy engagement.

Near constant unloading (tooth moving) forces regardless of the degree of deflection.

10/Pkg.

Etched midline marks
3 upper
1 lower

"Small" lower has one etched mid line and an additional etch mark 20 mm distal of mid line on right side.

** Add CS to part number to receive no drift center stop feature.*

Example: 226CS-14U is Symmetry III form with center stop size 014 upper

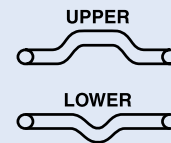

Applies to page 3-9

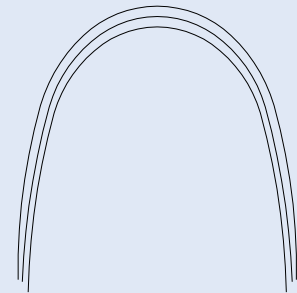

Symmetry *IP*
Etched Midlines

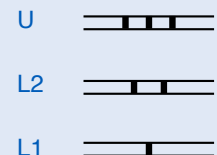

⁽¹⁾ SE Original RCS has moderate curve of spee, lingual crown torque, and distal toe-in.

A Proprietary & Premium Product

Exclusively Phoenix-USA

Pro Force Nickel Titanium



DIAMETERS	SYMMETRY*	SYMMETRY II*
012U	200-12U	201-12U
012L	200-12L	201-12L
014U	200-14U	201-14U
014L	200-14L	201-14L
016U	200-16U	201-16U
016L	200-16L	201-16L
018U	200-18U	201-18U
018L	200-18L	201-18L
020U	200-20U	201-20U
020L	200-20L	201-20L
016x016U	200-16x16U	201-16x16U
016x016L	200-16x16L	201-16x16L
016x022U	200-16x22U	201-16x22U
016x022L	200-16x22L	201-16x22L
—	—	—
—	—	—
017x025U	200-17x25U	201-17x25U
017x025L	200-17x25L	201-17x25L
018x018U	200-18x18U	201-18x18U
018x018L	200-18x18L	201-18x18L
018x025U	200-18x25U	201-18x25U
018x025L	200-18x25L	201-18x25L
019x025U	200-19x25U	201-19x25U
019x025L	200-19x25L	201-19x25L
020x020U	200-20x20U	201-20x20U
020x020L	200-20x20L	201-20x20L
021x025U	200-21x25U	201-21x25U
021x025L	200-21x25L	201-21x25L



**ORIGINAL
RCS ⁽²⁾**

**"H" TYPE
RCS ⁽¹⁾**

—	—
—	—
—	208-14U
—	208-14L
207-16U	208-16U
207-16L	208-16L
207-18U	208-18U
207-18L	208-18L
207-20U	208-20U
207-20L	208-20L
207-16x16U	208-16x16U
207-16x16L	208-16x16L
207-16x22U	208-16x22U
207-16x22L	208-16x22L
—	208-16x25U
—	208-16x25L
207-17x25U	208-17x25U
207-17x25L	208-17x25L
—	—
—	—
—	208-18x25U
—	208-18x25L
207-19x25U	208-19x25U
207-19x25L	208-19x25L
—	—
—	—
207-21x25U	—
207-21x25L	—

**Center Stop
Not Available**

**Center Stop
Not Available**

⁽¹⁾ "H" Type RCS has straight posterior sections, no lingual crown torque, and the deepest curve of spee.

⁽²⁾ Original RCS offers the most distal toe-in to control molar rotation in extraction cases and moderate curve of spee and lingual crown torque.

***CENTER STOP AVAILABLE**

Pro Force Nickel Titanium

Progressive loading and unloading forces in a moderate range that can increase efficiency and require fewer arch wire changes. The higher the degree of deflection, the greater the return or tooth moving forces.

Highly effective in space closure/retractions, stubborn rotations, leveling and arch form development.

Rectangular dimensions are excellent finishing wires where complete torque is desired.

Detailing in the vertical and horizontal planes is accomplished with our narrow tip three prong plier.

Our original Nickel Titanium wire that delivers the force when you need it.

10/Pkg.

Etched midlines
3 upper
1 lower

* Add CS to part number to receive no drift center stop feature.

Example: 201CS-16x22U is Symmetry II form with center stop size 016x022 upper

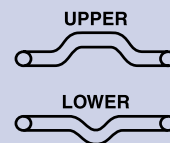

Applies to page 3-11

Molybdenum Titanium Alloy – MTA



DIAMETERS SYMMETRY SYMMETRY II

012U	—	—
012L	—	—
014U	—	—
014L	—	—
016U	250-16U	252-16U
016L	250-16L	252-16L
018U	250-18U	252-18U
018L	250-18L	252-18L
020U	—	—
020L	—	—
016x016U	250-16x16U	252-16x16U
016x016L	250-16x16L	252-16x16L
016x022U	250-16x22U	252-16x22U
016x022L	250-16x22L	252-16x22L
017x025U	250-17x25U	252-17x25U
017x025L	250-17x25L	252-17x25L
018x018U	250-18x18U	252-18x18U
018x018L	250-18x18L	252-18x18L
018x025U	250-18x25U	252-18x25U
018x025L	250-18x25L	252-18x25L
019x025U	250-19x25U	252-19x25U
019x025L	250-19x25L	252-19x25L
020x020U	—	—
020x020L	—	—
021x025U	250-21x25U	252-21x25U
021x025L	250-21x25L	252-21x25L

**SYMMETRY
“M” LOOP**



250-M-16x22

250-M-17x25

250-M-19x25

- Space Closure
 - Anterior Retraction and/or intrusion
 - Reduced Force Decay compared to Stainless Steel
 - Upper Sizes 36-46 mm (no 44) and 52 and 56 mm
 - Lower Sizes 24-34 mm
- 5/Pkg.



Wire Size	MTA
013U	—
014U	—
016U	—
018U	—
020U	—
014x025U	—
016x022U	254-16x22U
016x025U	—
017x025U	254-17x25U
018x025U	254-18x25U
019x025U	254-19x25U
018x018U	—
020x020U	—
013L2	—
014L2	—
016L2	—
018L2	—
020L2	—
014x025L2	—
016x022L2	254-16x22L2
016x025L2	—
017x025L2	254-17x25L2
018x025L2	254-18x25L2
019x025L2	254-19x25L2
018x018L2	—
020x020L2	—
013L1	—
014L1	—
016L1	—
018L1	—
020L1	—
014x025L1	—
016x022L1	254-16x22L1
016x025L1	—
017x025L1	254-17x25L1
018x025L1	254-18x25L1
019x025L1	254-19x25L1
018x018L1	—
020x020L1	—

Center Stop Not Available

Molybdenum Titanium Alloy – MTA

This special alloy provides forces midway between Pro Force Nickel Titanium and Stainless Steel, while offering some of the memory benefit of Nickel Titanium and the bendability of Stainless Steel.

Careful processing of this alloy has effectively eliminated breakage.

Excellent for torque control

The ideal retraction loop wire and the smooth finish reduces friction.

Long distal lengths of arches allows for multiple loops and detailing, and the treatment of second molars if desired.

10/Pkg.

Etched midlines
3 upper
1 lower

Applies to page 3-13

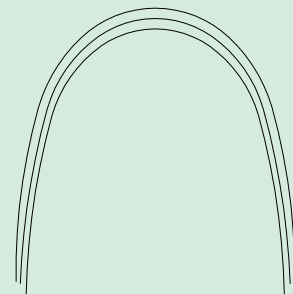

Symmetry^{IP}
Etched Midlines

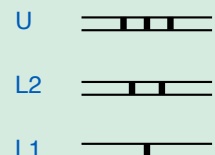

A Proprietary & Premium Product

Exclusively Phoenix-USA

Stainless Steel Resilient



DIAMETERS	SYMMETRY*	SYMMETRY SMALL	SYMMETRY II*	SYMMETRY III SMALL	SYMMETRY IV TAPERED
012U	—	—	—	—	—
012L	—	—	—	—	—
014U	100-14U	—	101-14U	141-14U	117-14U
014L	100-14L	100SM-14L	101-14L	141-14L	117-14L
016U	100-16U	—	101-16U	141-16U	117-16U
016L	100-16L	100SM-16L	101-16L	141-16L	117-16L
018U	100-18U	—	101-18U	141-18U	117-18U
018L	100-18L	100SM-18L	101-18L	141-18L	117-18L
020U	100-20U	—	101-20U	141-20U	117-20U
020L	100-20L	100SM-20L	101-20L	141-20L	117-20L
016x016U	100-16x16U	—	101-16x16U	141-16x16U	117-16x16U
016x016L	100-16x16L	—	101-16x16L	141-16x16L	117-16x16L
016x022U	100-16x22U	—	101-16x22U	141-16x22U	117-16x22U
016x022L	100-16x22L	100SM-16x22L	101-16x22L	141-16x22L	117-16x22L
016x025	—	—	—	—	—
017x022U	100-17x22U	—	—	—	—
017x022L	100-17x22L	—	—	—	—
017x025U	100-17x25U	100SM-17x25L	101-17x25U	141-17x25U	117-17x25U
017x025L	100-17x25L	—	101-17x25L	141-17x25L	117-17x25L
018x018U	—	—	—	—	—
018x018L	—	—	—	—	—
018x022U	100-18x22U	—	101-18x22U	—	—
018x022L	100-18x22L	—	101-18x22L	—	—
018x025U	100-18x25U	—	101-18x25U	141-18x25U	117-18x25U
018x025L	100-18x25L	100SM-18x25L	101-18x25L	141-18x25L	117-18x25L
019x025U	100-19x25U	—	101-19x25U	141-19x25U	117-19x25U
019x025L	100-19x25L	100SM-19x25L	101-19x25L	141-19x25L	117-19x25L
020x020U	—	—	—	—	—
020x020L	—	—	—	—	—
021x025U	100-21x25U	—	101-21x25U	141-21x25U	117-21x25U
021x025L	100-21x25L	—	101-21x25L	141-21x25L	117-21x25L



Wire Size	Stainless Steel
013U	—
014U	124-14U
016U	124-16U
018U	124-18U
020U	—
014x025U	—
016x022U	124-16x22U
016x025U	—
017x025U	124-17x25U
018x025U	124-18x25U
019x025U	124-19x25U
018x018U	—
020x020U	124-20x20U
013L2	—
014L2	124-14L2
016L2	124-16L2
018L2	124-18L2
020L2	—
014x025L2	—
016x022L2	124-16x22L2
016x025L2	—
017x025L2	124-17x25L2
018x025L2	124-18x25L2
019x025L2	124-19x25L2
018x018L2	—
020x020L2	124-20x20L2
013L1	—
014L1	124-14L1
016L1	124-16L1
018L1	124-18L1
020L1	—
014x025L1	—
016x022L1	124-16x22L1
016x025L1	—
017x025L1	124-17x25L1
018x025L1	124-18x25L1
019x025L1	124-19x25L1
018x018L1	—
020x020L1	124-20x20L1

Stainless Steel Resilient

Ultra smooth bright mirror finish

Torque control at less than the industry allowable 3°

100 Round/Pkg.
10 Square or Rectangular/Pkg.

Etched midlines

3 upper
1 lower

“Small” lower has one etched mid line and an additional etch mark 20 mm distal of mid line on right side.

Applies to page 3-15

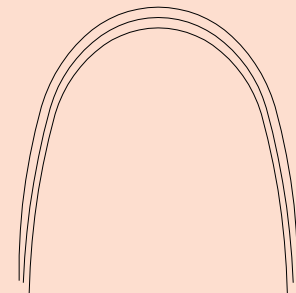

Symmetry^{IP}
Etched Midlines



*Thank you for using
Phoenix products*

Visit our website at
phoenixorthodonticsgeorgia.com

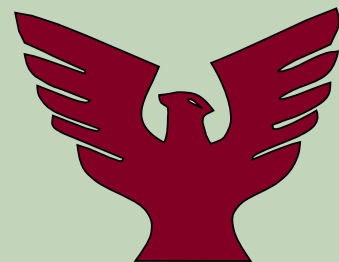

SPECIAL WIRES AND WIRE AUXILIARIES

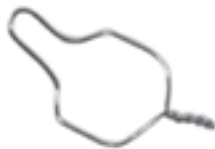

Page 1 Nickel Titanium Open Coil Springs, Distalizing Springs

Page 2 Nickel Titanium Closed Coil Springs, Stainless Steel Open and Closed Coil Springs

Page 3 Arch Wire Stops

Page 4 Arch Wire Hooks

Page 5 Nickel Titanium Torquing Wires, Phoenix Torqued RCS – Pro Force

Page 6 Stainless Steel Specialty Wires, 8 Braid, Co-Axial and Twist

Page 7 Stainless Steel Short and Long Ligature Wires and Kobayashi Hooks

Page 8 SE Nickel Titanium 15' Spools, N/T Separating Springs, and Anterior Torquing Springs

Page 9-10 Basic Arch Forms, Nickel Titanium and Stainless Steel



N/T Open Coil Springs – Variable Force



21" SPOOLS	ITEM #
009x030	219-05-9/30
010x030	219-05-10/30
010x036	219-05-10/36
012x030	219-05-12/30
014x030	219-05-14/30
014x036	219-05-14/36



VARIABLE FORCE COIL SPRINGS			
Wire Size	I.D.	*25% Compression	*50% Compression
.009	.030	95	225
.010	.030	120	260
.010	.036	90	200
.012	.030	220	480
.014	.030	360	700
.014	.036	270	560
.014	.045*	280	400

*Force in grams measured by compressing a 25 mm length to 18.75 mm (25%) and 12.5 mm (50%)
*measured 10 mm length @ 25 + 50%



N/T Distalizing Springs

STRAIGHT

LENGTHS 3x7"	ITEM #
010x036	219D-10/36
010x045	219D-10/45
011x045	219D-11/45

DISTALIZING SPRINGS				
Wire Size	I.D.	Two Segments Compressed	2 mm	4 mm
.010	.036		120	160
.010	.045		110	140
.011	.045		135	200

*Force expressed in grams



**Nickel Titanium
C/F Constant Force Closed Coils**

9 mm

12 mm



ITEM #
221C-L-9 (150gr.)
221C-M-9 (200gr.)
221C-H-9 (250gr.)
10/Pkg.

ITEM #
221C-L-12
221C-M-12
221C-H-12

FORCE RATING						
Extension Measurement (mm) / Subsequent Force Values (gms)						
Force	Size	2.5 mm	5 mm	7 mm	10 mm	12 mm
Light (150g)	9 mm	95	115	105	120	150
Medium (200g)	9 mm	140	150	160	175	200
Heavy (250g)	9 mm	195	200	215	240	300
Force	Size	5 mm	10 mm	15 mm	19 mm	24 mm
Light (150g)	12 mm	95	100	105	115	150
Medium (200g)	12 mm	140	150	160	180	200
Heavy (250g)	12 mm	190	200	215	240	250
9 mm have 12 mm maximum extension 12 mm have 24 mm maximum extension						

Stainless Steel



Open Coil Spring 010x030, 40" Spools

ITEM #
108O-10/30 010x030 – open

Closed Coil Spring 010x030, 40" Spools

ITEM #
109C-10/30 010x030 – closed



Mini Crimpable Stops

- Two arch wire specific sizes
- Bright shiny finish
- Tubular design crimps with Weingardt
- Smooth and comfortable

ITEM

- 189 S Small (fits .012-.018) 50/Pkg.
189 L Large (fits .020 & all rectangular) 50/Pkg.



Etched Stops

- Universal fit for all arch wires
- Gray oxide appearance
- Can be crimped without removing wire
- Crimp once at mesial and distal end

ITEM

- 181-12/22 100/Pkg.



Split Rectangular Stops

ITEM

- #181-18/22
100/Pkg. as 10 strips of 10 each



TAD Open Wall Stop

- 2 mm in length
- Fits .018 through .021 x .025 wire
- Designed to immobilize TAD vertical or cross tubes

ITEM

- 191M 10/Pkg.



Stop Locks

ITEM

- 188-22 Fits all arch wires
5/Pkg.

Wrench for Stop Locks

ITEM

- 136SLW





Split Surgical Ball Hook & Stop

Works on 16x22 through 19x25 wires

ITEM #

182-18/22 (Italy) 10/Pkg.



Split Curved Ball Hook & Stop

ITEM #

182-18/22R (Brazil)

182-18/22L

(works on 16x22 through 19x25 wires; specify right or left)

10/Pkg.



Closed Rectangular Ball Hook & Stop

ITEM #

185-18 .018x.025

185-22 .021x.025

10/Pkg.



Closed Rectangular Curved Ball Hook & Stop

ITEM #

184-18 .018x.025

184-22 .021x.025

10/Pkg.



Short Crimpable Hook

- 2 mm short split surgical hook
- Domed head allows for multidirectional engagement
- Fits .016 x .022 through .021 x .025 wire
- Crimp once mesial/distal with hard wire cutter

ITEM #

190S 10/Pkg.



Long Crimpable Hook

- 6 mm tall directional split hook
- Useful with TAD auxiliaries
- Fits .016 x .022 through .021 x .025 wire

ITEM #

190LR Right 10/Pkg

190LL Left 10/Pkg.



Symmetry SE Torquing Arches

PRE-TORQUED @ 20° IN THREE mm SIZES

SIZE	ITEM #
016x022	230-16x22 (28) (34) (38)
017x025	230-17x25 (28) (34) (38)
019x025	230-19x25 (28) (34) (38)
021x025	230-21x25 (28) (34) (38)

5/Pkg.

28 mm – 1 mid line

34 mm – 2 mid line

38 mm – 3 mid line

SYMMETRY

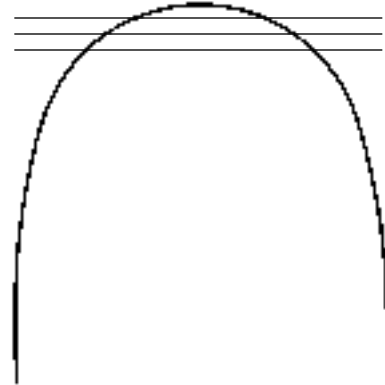

Phoenix Torqued RCS – Pro Force

- 20 Degrees of labial root torque placed at 34 and 38mm increments
- Align and level while providing anterior torque control
- Moderate arch width and molar rotation control

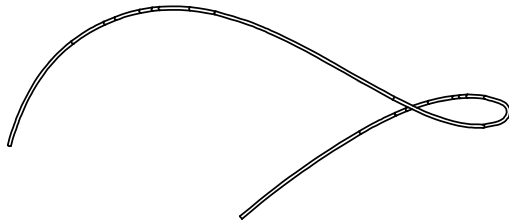

5/Pkg.

SIZE	ITEM #
16x25	246-16x25 (34-2)
17x25	246-17x25 (34-2)
19x25	246-19x25 (34-2)

with 34mm torque area and two etched mid lines

SIZE	ITEM #
16x25	246-16x25 (38-3)
17x25	246-17x25 (38-3)
19x25	246-19x25 (38-3)

with 38mm torque area and three etched mid lines

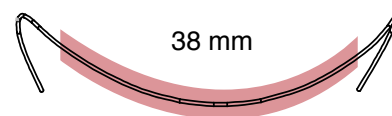



Stainless Steel Specialty Wires/Auxiliaries

Stainless Steel Specialty Wires

8 Braid



SYMMETRY

#110

110-16x22	(016x022)
110-17x25	(017x025)
110-18x25	(018x025)
110-19x25	(019x025)
110-21x25	(021x025)

10/Pkg.

Specify Upper or Lower

SYMMETRY II

#111



111-16x22	(016x022)
111-17x25	(017x025)
111-19x25	(019x025)

10/Pkg.

Specify Upper or Lower

Co-Axial

6 STRAND 30' Spools



ITEM

115-SP-155	0155
115-SP-175	0175
115-SP-195	0195

Twist

3 STRAND 30' Spools



ITEM

112-SP-155	0155
112-SP-175	0175
112-SP-195	0195

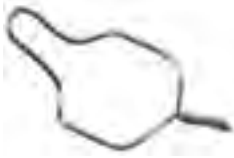

Ligature Wire – Short, Angulated, Pre-Formed

ITEM

107SL .010 1,000/Pkg.



Ligature Wire – Long

ITEM

107LL-08	.008	1,000/Pkg.
107LL-09	.009	1,000/Pkg.
107LL-10	.010	1,000/Pkg.
107LL-11	.011	1,000/Pkg.
107LL-12	.012	1,000/Pkg.
107LL-14	.014	500/Pkg.



Kobayashi Hooks – Short

ITEM

107SK-12	.012	
107SK-14	.014	100/Pkg.



Kobayashi Hooks – Long

ITEM

107LK-10	.010	
107LK-12	.012	
107LK-14	.014	100/Pkg.



SE Nickel Titanium

15' SPOOLS	ITEM #
012	224SP-12
014	224SP-14
016	224SP-16
018	224SP-18
020	224SP-20



N/T Separating Springs

	ITEM #		ITEM #	
018 Small (bicuspid)	220-S	016x022	220-16x22N	(narrow-molar/bicuspid)
018 Large (molar)	220-L	016x022*	220-16x22W	(wide-molar/molar)
25/Pkg.		017x025*	220-17x25L	(long-separator/deimpacting)

15/Pkg.

**Ideal for molar eruption when used with 014 S/E NT and Bonded Tubes*



220-16x22N



220-16x22W



220-17x25L

Anterior Torquing Springs

Applies torque to individual teeth.

Four sizes of springs to fit four rectangular archwires including the new 014x025 size which allows for earlier correction of needed torque, holding it longer in desired position, which should reduce relapse.

.011 heat treated cobalt chromium alloy wire applies optimum force with high fatigue resistance.

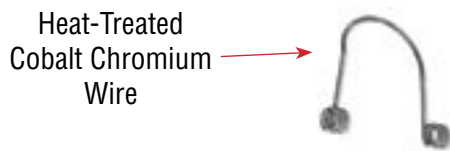

Heat-Treated Cobalt Chromium Wire



Elliptical Spring Shape

ITEM #		ITEM #
114-14/25		14/25
114-17/25		17/25
114-18/25		18/25
114-19/25		19/25

Sold 10/Pkg.

Basic Arch Forms: Nickel Titanium and Stainless Steel



The Basic Series is our response to those needing a more affordable line of arch wires, but still demanding the highest quality available. They are not your standard economy line arch wires of unknown materials, made in parts of the world that do not share our quality objectives.

They are manufactured of U.S. sourced materials in a U.S. plant that is FDA Registered, ISO Certified (international standards organization, for quality production), and CE Certified for export to Europe.

Mid lines are marked with our usual etched permanent markings: 3 Upper
1 Lower

Two shapes offered, Basic Natural-broad or square, and Basic Ovoid, in a wide range of sizes to meet the needs of most clinicians.

Economical Bulk Packaging: 25 wires per pack in Nickel Titanium
50 wires per pack in Stainless Steel

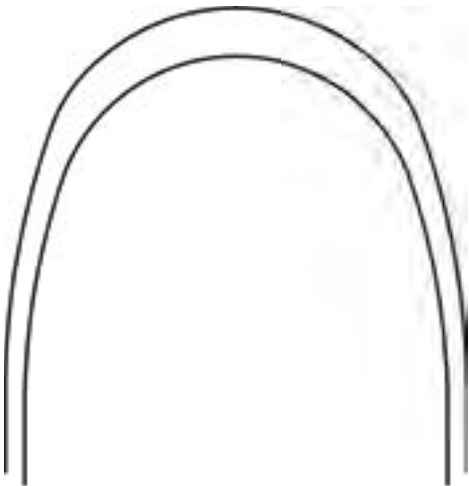

Basic Natural

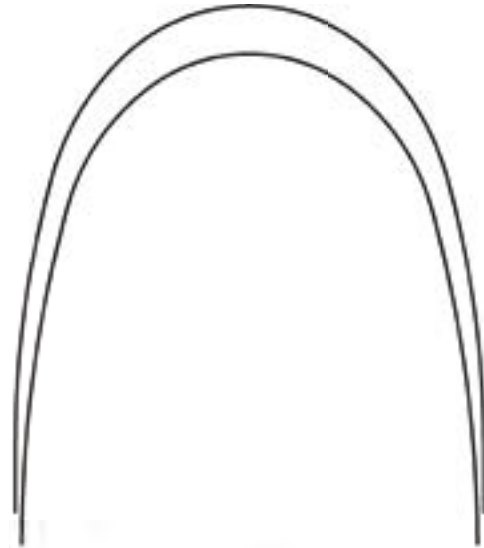

Basic Ovoid



Basic Arch Forms: Nickel Titanium and Stainless Steel



SIZES	BASIC NATURAL		BASIC OVOID	
	NICKEL TITANIUM	STAINLESS STEEL	NICKEL TITANIUM	STAINLESS STEEL
012U	BN-NT-12U		BOV-NT-12U	
012L	BN-NT-12L		BOV-NT-12L	
014U	BN-NT-14U	BN-SS-14U	BOV-NT-14U	BOV-SS-14U
014L	BN-NT-14L	BN-SS-14L	BOV-NT-14L	BOV-SS-14L
016U	BN-NT-16U	BN-SS-16U	BOV-NT-16U	BOV-SS-16U
016L	BN-NT-16L	BN-SS-16L	BOV-NT-16L	BOV-SS-16L
018U	BN-NT-18U	BN-SS-18U	BOV-NT-18U	BOV-SS-18U
018L	BN-NT-18L	BN-SS-18L	BOV-NT-18L	BOV-SS-18L
020U	BN-NT-20U	BN-SS-20U	BOV-NT-20U	BOV-SS-20U
020L	BN-NT-20L	BN-SS-20L	BOV-NT-20L	BOV-SS-20L
014x025U	BN-NT-14x25U		BOV-NT-14x25U	
014x025L	BN-NT-14x25L		BOV-NT-14x25L	
016x016U				
016x016L				
016x022U	BN-NT-16x22U	BN-SS-16x22U	BOV-NT-16x22U	BOV-SS-16x22U
016x022L	BN-NT-16x22L	BN-SS-16x22L	BOV-NT-16x22L	BOV-SS-16x22L
016x025U	BN-NT-16x25U		BOV-NT-16x25U	
016x025L	BN-NT-16x25L		BOV-NT-16x25L	
017x025U	BN-NT-17x25U	BN-SS-17x25U	BOV-NT-17x25U	BOV-SS-17x25U
017x025L	BN-NT-17x25L	BN-SS-17x25L	BOV-NT-17x25L	BOV-SS-17x25L
018x018U				
018x018L				
018x025U	BN-NT-18x25U	BN-SS-18X25U	BOV-NT-18x25U	BOV-SS-18x25U
018x025L	BN-NT-18x25L	BN-SS-18X25L	BOV-NT-18x25L	BOV-SS-18x25L
019x025U	BN-NT-19x25U	BN-SS-19x25U	BOV-NT-19x25U	BOV-SS-19x25U
019x025L	BN-NT-19x25L	BN-SS-19x25L	BOV-NT-19x25L	BOV-SS-19x25L
020x020U	BN-NT-20x20U		BOV-NT-20x20U	BOV-SS-20x20U
020x020L	BN-NT-20x20L		BOV-NT-20x20L	BOV-SS-20x20L
021x025U		BN-SS-21x25U		BOV-SS-21x25U
021x025L		BN-SS-21x25L		BOV-SS-21x25L

*Thank you for using
Phoenix products*

Visit our website at
phoenixorthodonticsgeorgia.com

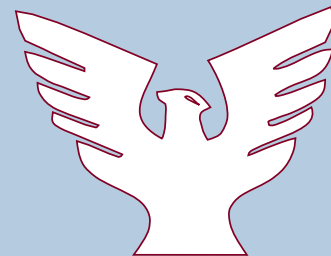

PHOENIX
ORTHODONTICS

ELASTOMERIC FORCE SYSTEMS AND AUXILIARIES

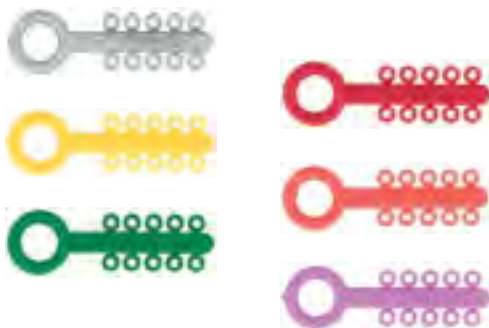
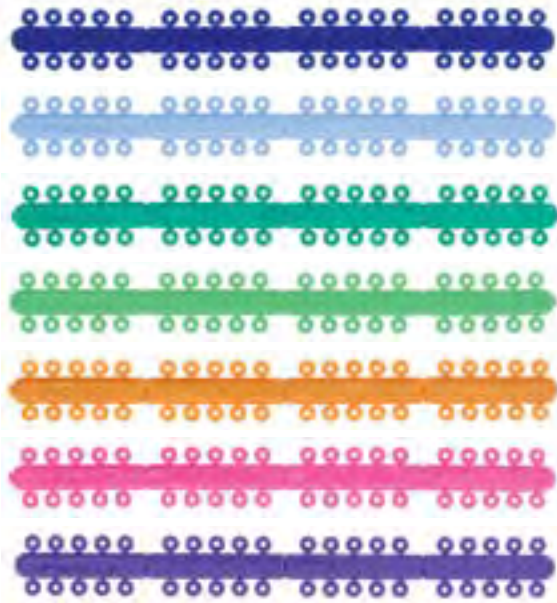

Page 1 Straight, Key, and Single Use Ties

Page 2 Color Chart for Ties and Chain Elastic

Page 3 Chain Elastic, Solid and Hollow Threads, Arch Wire Sleeve

Page 4 Phoenix Intra-Oral Elastics – Natural Amber and Neon, Extra Oral Latex Elastics, Elastic Attachers

Page 5 Latex Free Clear Elastics, Radiopaque Separators

Page 6 Endura High Performance Chain



Elastomeric Force Systems



A Proprietary & Premium Product

Exclusively Phoenix-USA

Straight Ties SER, Superior Elastic Recovery



- Ideal for extended patient visits of 6 to 10 weeks, SER ties keep the arch wire securely ligated to the bottom of the slot affording more efficient tooth movement.
- SER ties are the strongest we offer at 42 oz. but highly elastic for ease of placement and removal.
- Molded in groups of 10 each for easy cutting to avoid cross contamination.
- 1000 ties per package.

Key Ties



- A moderate force tie at 30 oz. for regular use and normal patient visits.
- Ten ties per runner allows use of two colors on fully bracketed cases and no remaining modules – no cross contamination – no sterilization required.
- Larger inner opening of module combined with a flatter cross section allows for easier tying and improved fit on tie wings.
- 1000 ties per package.

Single Use Ties



- A lighter force tie at 22 oz. for ease of ligation and to aid in figure 8 tying.
- Ten ties per runner allows use of two colors on fully bracketed cases and no remaining modules – no cross contamination – no sterilization required.
- 1000 ties per package.



Elastomeric Force Systems

A Proprietary & Premium Product

Exclusively Phoenix-USA

Color Chip	Color Name Code	Abbreviation	Straight Tie #300	Single Use Tie #301	Key Tie #330	Chain Elastic	
						Continuous #304	Open #302
	Aquamarine	Aq	300-Aq	301-Aq	330-Aq	304-Aq	302-Aq
	Azure	Az	300-Az	301-Az	330-Az	304-Az	302-Az
	Black	Bl	300-Bl	301-Bl	330-Bl	304-Bl	302-Bl
	Blue	B	300-B	301-B	330-B	304-B	302-B
	Bubble Gum	Bg	300-Bg	301-Bg	330-Bg	304-Bg	302-Bg
	Clear	Cl	300-Cl	301-Cl	330-Cl	304-Cl	302-Cl
	Cobalt	Cb	300-Cb	301-Cb	330-Cb	304-Cb	302-Cb
	Coral	C	300-C	301-C	330-C	304-C	302-C
	Green	Gn	300-Gn	301-Gn	330-Gn	304-Gn	302-Gn
	Grey	Gr	300-Gr	301-Gr	330-Gr	304-Gr	302-Gr
	Gold	Gd	300-Gd	301-Gd	330-Gd	304-Gd	302-Gd
	Lavender	L	300-L	301-L	330-L	304-L	302-L
	Light Blue	Lb	300-Lb	301-Lb	330-Lb	304-Lb	302-Lb
	Lime Green	LiG	300-LiG	301-LiG	330-LiG	304-LiG	302-LiG
	Maroon	M	300-M	301-M	330-M	304-M	302-M
	Mint	Mi	300-Mi	301-Mi	330-Mi	304-Mi	302-Mi
	Navy	N	300-N	301-N	330-N	304-N	302-N
	Orange	O	300-O	301-O	330-O	304-O	302-O
	Perfect Pink	Pp	300-Pp	301-Pp	330-Pp	304-Pp	302-Pp
	Purple	P	300-P	301-P	330-P	304-P	302-P
	Red	R	300-R	301-R	330-R	304-R	302-R
	Silver	Sv	300-Sv	301-Sv	330-Sv	304-Sv	302-Sv
	Smoke	S	300-S	301-S	330-S	304-S	302-S
	Violet	V	300-V	301-V	330-V	304-V	302-V
	White	W	300-W	301-W	330-W	304-W	302-W
	Yellow	Y	300-Y	301-Y	330-Y	304-Y	302-Y
	Porcelain	PO		301-PO	330-PO	304-PO	302-PO



A Proprietary & Premium Product

Exclusively Phoenix-USA

Chain Elastic



- Consistent and uniform forces over a longer period of time.
- 27 colors with excellent stability and stain resistance.
- Color matched to our three ligature ties.
- 15 ft. Spools

	ITEM #
Long	303
Open	302
Continuous	304

Thread – Solid, Textured



- Solid Textured Thread for greater strength to control rotations and retractions
- 25 ft. Spool
- Thread is “textured” to hold knots securely

	ITEM #
020 Clear	321-20C
020 Grey	321-20G
025 Clear	321-25C
025 Grey	321-25G
030 Clear	321-30C
030 Grey	321-30G

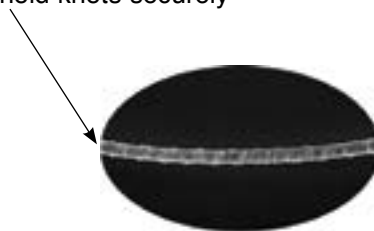

Thread – Hollow



- Hollow Thread for secure knotting.
- 50 ft. Spool

	ITEM #
025 Clear	322-25C
025 Grey	322-25G
030 Clear	322-30C
030 Grey	322-30G

Arch Wire Sleeve



- Fits maximum of .019x.025 arch wire
- 10 ft. Spool

	ITEM #
Clear	324-C
Grey	324-G



Elastomeric Force Systems

A Proprietary & Premium Product

Exclusively Phoenix-USA

Phoenix Precision Cut Pure Latex Elastics

Diameter Sizes	2.5 oz	3.5 oz	4.5 oz	6 oz	8 oz
1/8" (3.2 mm)	Red A* 450-RA	Green A 450-GA	Blue A 450-BA	Orange A 450-ORA	—
3/16" (4.8 mm)	Red B* 450-RB	Green B 450-GB	Blue B 450-BB	Orange B 450-ORB	Purple B* 450-PB
1/4" (6.4 mm)	Red C* 450-RC	Green C 450-GC	Blue C 450-BC	Orange C 450-ORC	Purple C* 450-PC
5/16" (7.9 mm)	Red D* 450-RD	Green D 450-GD	Blue D 450-BD	Orange D 450-ORD	Purple D* 450-PD
3/8" (9.5 mm)	Red E* 450-RE	Green E 450-GE	Blue E 450-BE	Orange E 450-ORE	—

- Color Coded patient packs for easy identification. Heat sealed with tear-off strip for safety.
- Consistent Force Delivery – measured at three times passive diameter.
- Each patient pack printed with a chart allows you to mark instructions for where and when to wear.
- Master pouches contain 100 patient packs of 100 elastics each.
- Natural or Neon or color. Item numbers above with * (asterisk) **are not available in Neon.**



ITEM #
450-___ (Natural)



ITEM #
450N-___ (Neon)

Extra Oral Latex Elastics



- One bulk pack of 1,000 elastics.
- Natural only.

ITEM #
450E-8 Size 1/2" x 8 oz.
450E-16 Size 1/2" x 16 oz.

Elastic Attachers



Aqua
Pink
Yellow
Orange
Purple

ITEM #
400EA2
100/Pkg.
Assorted



Latex Free Clear Elastics

	Purple 1/8"	Green 3/16"	Red 1/4"	Blue 5/16"	Orange 3/8"
Light 2 1/2 oz.	470-101	470-104	470-107	470-110	470-113
Medium 4 1/2 oz.	470-102	470-105	470-108	470-111	470-114
Heavy 6 1/2 oz.	470-103	470-106	470-109	470-112	470-115

- Ideal for latex sensitive patients.
- Made from a clear medical grade polymer that is odorless and tasteless.
- Color Coded patient packs for easy identification.
- Consistent Force Delivery – measured at three times passive diameter.
- Each patient pack printed with a chart allows you to mark instructions for where and when to wear.



ITEM

- 470 Pkg. of 50 patient packs of 100 elastics each.
- 470-N Neon special order 4 1/2 and 6 1/2 oz. only.

Radiopaque Separators – Loose



- Very durable – insert with floss or instrument.
- Visible on X-rays.
- Small and large sizes.

ITEM

- Large 311-LB
- Small 311-SB
- 1000/Pkg.



Endura High Performance Chain

A Proprietary & Premium Product
Exclusively Phoenix

Endura

high performance chain



Manufactured from premium medical-grade elastomeric material that is both stain resistant and tasteless, Endura Chain delivers a uniform, continuous force over significantly longer periods of time in comparison to other elastic chains.

Endura Chain FEATURES & BENEFITS

- Long-lasting and stain resistant with consistent, predictable force delivery over four weeks.
- Easy-handling light-proof dispensing spools. Each spool contains two meters (6.56 ft.) of chain.
- .018 material thickness allows easy ligation and “piggy-backing” with elastomeric modules. Endura Chain is an excellent choice for self-ligation, ceramic, and lingual brackets with limited tie wing areas.
- Available in continuous and medium linkages. Translucent clear and cosmetic grey color options.

Manufactured in Japan

	ITEM #
Endura Chain Clear Continuous	305-C
Endura Chain Grey Continuous	305-G
Endura Chain Clear Medium	306-C
Endura Chain Grey Medium	306-G

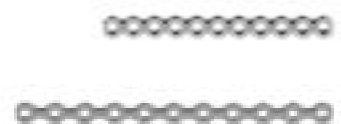

*Thank you for using
Phoenix products*

Visit our website at
phoenixorthodonticsgeorgia.com

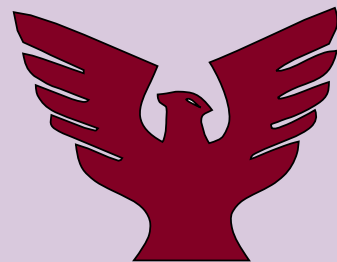

LAB SUPPLIES



Page 1 Leone 620 Palatal Expanders

Page 2 Leone Palatal Expanders with Pre-Bent Arms

Page 3 Leone Micro Palatal Expanders

Page 4 Leone Lower Arch Expanders, Fan Type Expanders

Page 5 Micro Palatal Expander "Easy Access"

Page 6 Leone Self Activating Nitinol Leaf Expanders, Gauge

Page 7 Flat Bow Retainer Wires, Adams Clasps

Page 8 Lab Wires – Stainless Steel, Blue Temp, MTA, Ball Clasps

Page 9 Preformed Lip Bumper with Loops, Thermal Insulator Paste

Page 10 Silver Solder, Solder Flux, Disposable Impression Trays

Page 11 Select Retainer Cases

Page 12 Mini Retainer Cases, Standard Retainer Cases



Leone Rapid Expander

Made entirely of biomedical stainless steel. The housing design is completely smooth, with no rough areas for a secure hygiene. The expander limit, a directional arrow and the lot number are laser etched into the surface of the expander body. Supplied with a swivel key with handle and instructions for use to facilitate the patient endoral activation.

1/Pkg. Italy

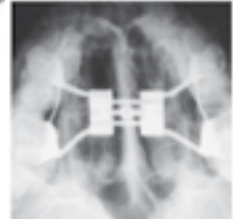

 11 mm	 4 mm	CODE	\varnothing arms mm	\longleftrightarrow body mm	\pm mm	\curvearrowright mm	ACTIVATION TURNS for maximum expansion limit
		A0620-08	1,5	12	8	0,8	35
		A0620-09	1,5	14	9	0,8	40
		A0620-11	1,5	16	11	0,8	50
		A0620-13	1,5	18	13	0,8	60
		A0620-15	1,5	20	15	0,8	70



Leash

100/Pkg. (Italy)

ITEM

A0557-02

Straight Keys

100/Pkg. (Italy)

ITEM

A0557-00

Bent Tip Keys

100/Pkg. (Italy)

ITEM

A0557-01



Swivel Key

10/Pkg.

ITEM

414



Arm Bending Instrument for Rapid Expansor

Allows for easy bending once inserted into the rapid Expansor arm. (Italy)

ITEM

P1620-01



Lab Supplies – Leone Expansor® Series











Leone Rapid Expander With Pre-Bent Arms

Exactly the same as A0620 expander for all technical features and materials used, but designed with pre-bent arms to facilitate the work in the laboratory. The front arms are more inclined than the rear arms to allow the positioning of the expander's body in the most comfortable way for the patient with the best biomechanical results. Provided with one swivel key with handle and instructions for use to facilitate the patient endoral activation.

1/Pkg. Italy



Swivel key included in the package

 11 mm	 4 mm	CODE	 arms mm	 body mm	 mm	 mm	ACTIVATION TURNS for maximum expansion limit
		A0620W08	1,5	12	8	0,8	35
		A0620W09	1,5	14	9	0,8	40
		A0620W11	1,5	16	11	0,8	50
		A0620W13	1,5	18	13	0,8	60



Leone Micro Rapid Expander with Telescopic Guides

The innovative telescopic guides assure a constant friction throughout the expansion movement, a perfect stability and small sizes. It self deactivates when maximum expansion capacity has been achieved preventing from over-treatment. The 7 mm expander is ideal to treat very narrow palates.

The expanders with 10 and 12 mm sizes feature a compact design for ease of arm bending and reducing the overall dimensions of the device.

Supplied with a swivel key with handle and instructions for use to facilitate patient endoral activation.

1/Pkg. Italy

11 mm	4 mm	axis	body	telescopic pins	activation key for maximum expansion limit	
		1,5 mm	11 mm	7 mm	0,8 mm	35
		1,5 mm	14 mm	10 mm	0,8 mm	50
		1,5 mm	16 mm	12 mm	0,8 mm	60



Telescopic Guide Pins*

Avoid the possibility of spontaneous deactivation in the mouth.

*International patent



Lab Supplies – Leone Expander Series



Leone Expander for Lower Arch

As a result of various marketing requests, we introduce the expander with longer arms compared to the previous model.

1/Pkg. Italy



Key with safety ring leash included in the package

75 mm	4 mm	Ø 1,5 mm	body	for maximum expansion level
A0623-08				
A0623-11				

Leone Ragno Fan-Type Rapid Expander and Mini Rapid Expander

Conceived with the cooperation of Dr. Eleonora Schelliono and Prof. Remo Modica Made entirely of biomedical stainless steel. The expanding arms are laser welded to the screw body. Laser engraved directional arrows on the MIM® body. It is a device for the rapid expansion of the palate that allows you to get a widening of the single anterior sector of the maxillary arch, still maintaining the expansion at the molar level. It self-deactivates when maximum expansion capacity has been achieved preventing from overtreatment. The difference between the two models is the geometric shape of the palate trying to determine the minimum encumbrance. The overall size is approximately 20-25% mm less than those of the 9 mm version. Provided with one swivel key with handle and instructions for use to facilitate the patient endoral activation.

1/Pkg. Italy



	Ø 1,5 mm	body	for maximum expansion level
A0625-09			
A0625-07			



MICRO EXPANDER FOR PALATAL SUTURE

EASY ACCESS

A1621 expander called “Easy Access” is comparable to the existing A0621, but once placed in the device, the body of the screw will remain closer to the palate with minimized overall dimensions; the head with activation holes remains in front position in respect to the guide pin for easier activation with the key.

Provided with one swivel key with handle and instructions for use to facilitate the patient endoral activation.

The arm bending and self-locking instrument is also available.

1/Pkg.



Swivel key included in the package



anterior position

holes of activation



easy access

for key activation

3 expansion value

for any therapeutic treatment

4,95 mm	4,05 mm	arms 1,5 mm	0,8 mm	body mm	activation turns for maximum expansion limit	
				12	8	35
				16	11	50
				18	13	60



Leone Leaf Self Expander (Patented)

Featuring all the advantages of the Leaf expander without the need of periodic reactivation. The work of this expander is assigned entirely to the flexible properties of the nickel titanium leaf springs releasing controlled and continuous forces. The choice of the expander is decided on the basis of the transverse discrepancy of the patient; therapy is therefore predetermined and no further action is required, neither by the clinician nor even by the patient. Available in two strength levels and two expansion capabilities to meet nearly all maxillary deficiencies.

1/Pkg. Italy

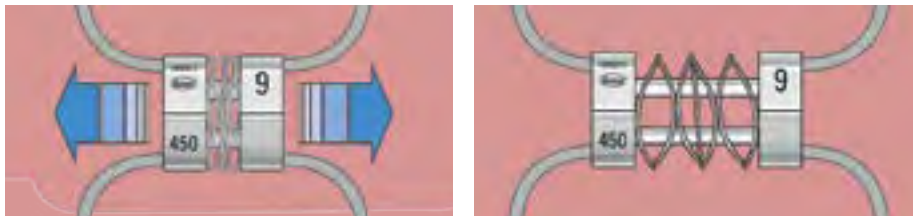

			CODE			
	11 mm	4 mm		arms mm	body mm	mm
			A2705-06 4 springs 450 g approx	1,5	12	6
			A2706-06 4 springs 900 g approx	1,5	12	6
			A2705-09 6 springs 450 g approx	1,5	12	9
			A2706-09 6 springs 900g approx	1,5	12	9

A2700-00 EXPANSION MEASURING GAUGE FOR LEAF EXPANDER*

Helpful to verify the expansion gained from the MEMORIA Leaf Spring Activated Expander and the need to activate the expander or compress the springs again. Easy to place design, it makes easier to check the expansion value directly into the mouth.

Made of steel, suitable for hot and cold sterilization.

1/Pkg.





Loops Angulated labially
7° for comfort

Flat Bows

.032 Stainless Steel Resilient Wires

Flattened Anterior Segment for Torque Control

10/Pkg.

		ITEM #
Size 1	28.5 mm	400 FB1
Size 2	31 mm	400 FB2
Size 3	35 mm	400 FB3
Size 4	38 mm	400 FB4
Size 5	41.3 mm	400 FB5
Size 6	44.5 mm	400 FB6
Size 7	47.6 mm	400 FB7
Size 8	50.8 mm	400 FB8

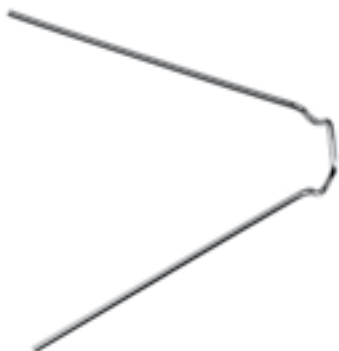

Sizes measured from
midline of loop to
midline of loop.

Adams Clasps

.028 Stainless Steel

100/Pkg.

	ITEM #
5 mm	409-5
6 mm	409-6
7 mm	409-7
8 mm	409-8
9 mm	409-9
10 mm	409-10
11 mm	409-11
12 mm	409-12



Stainless Steel Lab Wires

Pkg. of 10 x 14" Spring Temper

SIZE	ITEM #	SIZE	ITEM #
016	113-16	016 x 016	113-16x16
018	113-18	016 x 022	113-16x22
020	113-20	017 x 025	113-17x25
024	113-24	018 x 022	113-18x22
028	113-28	018 x 025	113-18x25
030	113-30	019 x 025	113-19x25
032	113-32	021 x 025	113-21x25
036	113-36		
040	113-40		
045	113-45		
051	113-51		
056	113-56		
060	113-60		

Blue Temp (Nickel Cobalt) Lab Wires

Pkg. of 25 x 14"

SIZE	ITEM #
028	113NC-28
030	113NC-30
032	113NC-32
036	113NC-36



MTA (Molybdenum Titanium Alloy) Lab Wires

Nickel Free Lab Wires

Pkg. of 10 x 14

SIZE	ITEM #
016	251-16
018	251-18
016 x 022	251-16x22
017 x 025	251-17x25
019 x 025	251-19x25
027	251-27
032	251-32
036	251-36

Ball Clasps Stainless Steel

Smooth, round head is twice the diameter of wire size.

100/Pkg.

SIZE	ITEM #
028	410-28
032	410-32
036	410-36



Lip Bumper

.045 with Loops

1/Pkg.
(Italy)

ITEM #
M3051-00



Thermal Insulator Paste

Highly visible green paste protects parts (stainless steel, plaster and resin) from being damaged by heat during soldering. Excellent consistency – easily removed with water.

235ml / 9 oz. Tube (Italy)

ITEM #
RO227-01



Silver Solder .025

(cadmium free) **ITEM #**
5 DWT 418-5
80 DWT 418-80

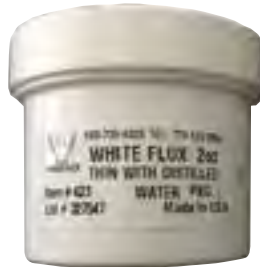

White Flux

2 oz. Jar **ITEM #**
423

Disposable Impression Trays

Rigid plastic trays with long handles for easy use. Rolled edges and open slots secure the alginate – no adhesives needed. Six sizes available numbered 1-6 and color coded. Sizes 1 and 2 are primarily pediatric and size 6 is extra large.

50/Pkg. One Size Upper or Lower

	ITEM #
Red Lower	400-IT1L
Red Upper	400-IT1U
Orange Lower	400-IT2L
Orange Upper	400-IT2U
Blue Lower	400-IT3L
Blue Upper	400-IT3U
Green Lower	400-IT4L
Green Upper	400-IT4U
Yellow Lower	400-IT5L
Yellow Upper	400-IT5U
Purple Lower	400-IT6L
Purple Upper	400-IT6U





Select Retainer Cases

Bright patient-pleasing colors and well made from strong high-impact plastic for maximum protection.

Sized to hold most retainers, appliances, and mouthguards. Ventilation holes, durable long life hinge, and inside clips to hold appliance keys.

1 3/8" deep, 3" wide, 2 3/4" front to back.

12/Pkg. of one color

ITEM #	400R-PI	400R-R	400R-B	400R-T	400R-BL	400R-O	400R-LB	400R-PL	400R-CL
	Pink	Red	Blue	Teal	Black	Orange	Light Blue	Plum	Clear





Mini Retainer Cases

Holds one vacuum formed Retainer (ideal when the lower retainer is bonded).
3/4" deep, 3" wide, 2 3/8" front to back.
12/Pkg. with labels
(Taiwan)

Colors – Black, Light Blue, Lime Green, Red, Violet, Yellow, Orange, and Pink



ITEM #	400R-MINI-BL Black	400R-MINI-B Blue	400R-MINI-G Green	400R-MINI-O Orange
	400R-MINI-PK Pink	400R-MINI-P Purple	400R-MINI-R Red	400R-MINI-Y Yellow

Standard Retainer Cases

Holds two Hawley Style Retainers.
1" deep, 3 1/8" wide, 2 5/8" front to back.
50 per box with labels

Cool Colors – 10 each of Aqua, Pink, Orange, Yellow, and Purple

ITEM #
400-RC



*Thank you for using
Phoenix products*

Visit our website at
phoenixorthodonticsgeorgia.com

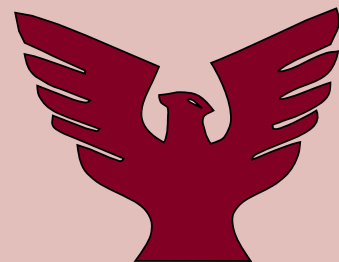

- Page 1 Light Bond™, Go To®, Pad Lock®
- Page 2 LCR Light Cure™ Retainer, Band-Lok®, Ultra Band-Lok®,
- Page 3 Flow Tain™, Pro Seal®, L.E.D. Pro Seal®, Assure® Sealant, Assure® Plus
- Page 4 Ortho FlexTech®, Sponge Pellets, Mixing Pads, Mixing Spatulas, Porcelain Conditioner
- Page 5 Metal Primer, Plastic Conditioner, Blue Gel Etch Syringe, Gel Etch 9 gm, Liquid Etch 9 gm, Liquid Etch 23 gm
- Page 6 Green Etch Syringe, Porc-Etch™ w/Barrier Gel, 1st and Final, Bond A Braid®, Renew Metal Burs and Finishing Points
- Page 7 T.K.O. Composite Bite Turbo Gel Pink, Microbrushes®, Long Primer Brushes, Carpule (Tips) Dispensing Gun
- Page 8 Mini Mold™ Kits, Access Cheek Retractor





Light Bond™

Highly filled material with fluoride. Maximum strength. Small filler particles promote ease of removal from enamel.

Separate Components:

	ITEM #
5 gm Light Bond Paste in Syringe Medium viscosity*	LBMPFF
5 gm Light Bond Paste in Tips Medium viscosity*	LBMPF
5 gm. Light Bond Paste in Syringe	LBPPF
5 gm. Light Bond Paste in Tips	LBPTF
3 cc. Light Bond Sealant	LBS3F
3 cc. Light Bond Filled Sealant	LBFSF
7 cc. Light Bond Sealant	LBFS7F
7 cc. Light Bond Filled Sealant	LBFS7F

*a customer preferred product



GoTo®

Light Cure adhesive for brackets and creating attachments for thermoplastic aligners.

No bracket drift and any flash removed in one piece.

[Will fluoresce under UV light.](#)

	ITEM #
4 gm. GoTo Syringe	GTP
4 gm. GoTo Tips	GTT



Pad Lock®

Bonds chemically and mechanically to metal bases of all types for increased strength.

[Will fluoresce under UV light.](#)

	ITEM #
4.5 gm. Syringe w/fluoride	PLPF
4.5 gm. Syringe w/fluoride, thin viscosity	PLTP



Reliance Adhesives & Accessories



LCR Light Cure™ Retainer

Designed specifically for bonded lingual retainers: pad or wire types and occlusal build up on posterior teeth.

	ITEM #
Push Syringe 5 gm LCR Syringe	LCR
Pre-loaded Syringe Tips 5 gm LCR Tips	LCRT5



Band-Lok® with Paste in Screw Syringe

Band-Lok does not have an aftertaste or odor.

Bonds chemically to metal bands and crowns. Removal all in one piece with cement on the appliance.

	ITEM #
6 gm. Band-Lok Paste A in Screw Syringe	BLSA
6 gm. Band-Lok Paste B in Screw Syringe	BLSB
6 gm. Band-Lok Paste A in Screw Syringe Blue	BLSAB



Ultra Band-Lok® with Paste in Push Syringe

Light Bond activated so no working constraints or waste from mixing. Chemically bonds to stainless steel.

	ITEM #
5 gm. Ultra Band-Lok Syringe	UBLPP
5 gm. Ultra Band-Lok Syringe Blue	UBLBPP

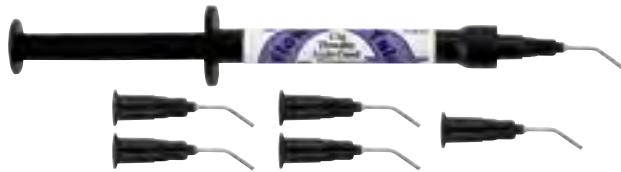

Flow Tain™ with Tips

Flow Tain™ light cured composites with a low modulus of elasticity – ideal for lingual retainers, splinting materials and indirect bonding of brackets. This material is highly polishable which will reduce wear.

Flowable Viscosity with thixotropic properties to prevent them from slumping for better control.

Needle Tip Dispenser

Cured Composite Flexibility Flow Tain™ has a low modulus of elasticity and is not as stiff or brittle as conventional composites.

Will fluoresce under UV light.

1 syringe with tips/Pkg.

ITEM #
FT



Pro Seal® L.E.D. Pro Seal

Light cure fluorescing filled sealant completely sets without any oxygen inhibited layer.

	ITEM #
1- 6 ml. bottle	PRO
1- 6 ml. bottle	LEDPRO



Assure® Sealant

Assure Sealant protects the enamel while bonding to normal, atypical, dry, or slightly contaminated enamel.

	ITEM #
1- 6 ml. bottle	AS



Assure® Plus

All surface bonding resin performs as Assure (AS) plus porcelain, zirconia, and acrylic temporary/pontic teeth can be bonded.

	ITEM #
1- 6 ml. bottle	PLUS



Reliance Adhesives & Accessories



Ortho FlexTech® Dental Retention System *The Next Generation in Lingual Retention*

- Easy application – naturally forms to lingual arch curvature
- Low failure rate due to “flex linkage”
- Improved patient comfort – lays flat against the teeth
- 14 karat gold composition

	ITEM #
1 - 30” Spool/Pkg.	OFT2
Stainless Steel Ortho FlexTech®	SSOFT
1 - 30” Spool/Pkg.	



Sponge Pellets

500/Pkg.

ITEM #
SP

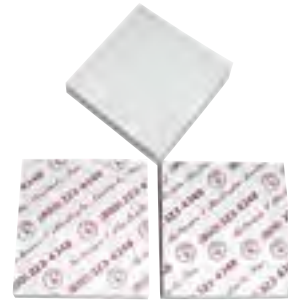

Mixing Pads

Non Absorbent
1/Pkg.

ITEM #
1PADS



Nylon Mixing Spatulas

Reusable
50/Pkg.

ITEM #
S



Porcelain Conditioner

For Bonding to Ceramic Crowns

8 cc.

ITEM #
PO



Metal Primer

For Bonding to Gold, Stainless Steel and Amalgam

8 ml.

ITEM #
ME



Plastic Conditioner

For Bonding to Composite Restorations, or Acrylic Appliances

10 cc.

ITEM #
PL



Blue Gel Etchant in Syringe

High visibility, high viscosity blue gel enamel etchant, with anti-microbial to prevent bacteria buildup after etching

ITEM #

Etchant in one syringe 5 gm and one pkg. of tips

BEGS



Etchant – Gel

9 gm.

ITEM #
EG9



Etchant – Liquid

9 gm.

ITEM #
EL9



Economy Etchant Liquid

23 gm.

ITEM #
EL24



Reliance Adhesives & Accessories



Green Gel Etchant in Syringe

Etchant in one syringe
6.5 gm. and two pkgs. of
tips

ITEM #
EGSS



Porc-Etch™

Porcelain Etching Agent
with Barrier Gel

9 gm. etch ITEM #
POE



1st & Final

Prepackaged Orthodontic Pumice

200/Pkg. ITEM #
FF



Bond-A-Braid® Hilgers

Lingual Retainer Wire
Permanent retention is greatly
enhanced using a flattened, dead
soft 8-braid wire.

10/Pkg. ITEM #
BAB2

Renew® System Burs

Renew Bur 118S ITEM #
RSB



Renew Bur 118L RSBL



Renew Finish RS, Friction Grip RSPFG-12pkg



Tapered 218 ITEM #
RSB2



Renew Finish, Latch Grip RSPL-12pkg





T.K.O. - Composite Bite Turbo Gel Pink

Looking for a Triad substitute? Reliance is excited to introduce T.K.O.!

- Quick light cure acrylic repair
- Gentle impact Resin Matrix (great for occlusal build ups)
- Needle tip dispensing for accurate and ergonomic placement
- Will not wear opposing tooth structure. Relatively easy to remove at the end of treatment
- Used in both lab and chairside settings
- Pink shade to contrast enamel
- Contains one 3.4g TKOP syringe with 5 tips

ITEM #
1 TKOP



Microbrushes®

4/Pkg.

ITEM #
400-MB



Primer Brushes, Long 4"

To reach posterior sections – can be angled. (Taiwan)
100/Pkg.

ITEM
400-LB



Carpule Dispensing Gun

Accepts Reliance and most carpules.
Carpules lock in place – no rotation while dispensing adhesive. Autoclavable to 275°F. (Taiwan)

ITEM #
CDG



Reliance Adhesives & Accessories

Mini Mold Kits

Fabricate needed accessories by attaching the flexible mold to the handle, filling the mold with Light Bond Adhesive, and curing on the prepared tooth.



Habit Corrector
10/Pkg.
ITEM # 702



Anterior Bite Ramp 3 mm
8/Pkg.
ITEM # 703-3



Anterior Bite Ramp 5 mm
8/Pkg.
ITEM # 703-5
ITEM # 703-7
Bite Ramp 7 mm
Not shown 8/Pkg.



Button Bonder
10/Pkg.
ITEM # 704



Posterior Bite Bumper
10/Pkg.
ITEM # 706



Bracket Bonder
10/Pkg.
ITEM # 707



Wire Bonder Small – Lower Cen./Lat.
10/Pkg.
ITEM # 708-S



Wire Bonder Large – Cuspids
10/Pkg.
ITEM # 708-L



Tube Bonder
10/Pkg.
ITEM # 709



Cuspid Bite Ramp
8/Pkg.
ITEM # 710

ITEM # 705 Mini mold handle only (not shown) 1/Pkg.

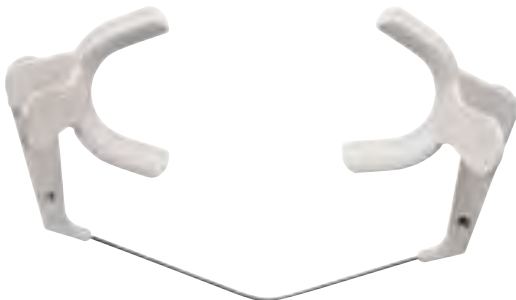

Access Cheek Retractor

Sterilize to 370° F – 1/Pkg.

	ITEM #
Adult	CH1
Child	CH2

*Thank you for using
Phoenix products*

Visit our website at
phoenixorthodonticsgeorgia.com

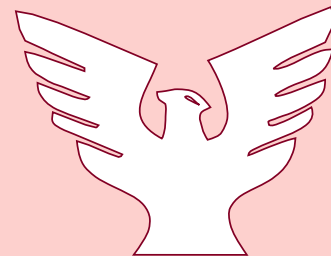

PHOENIX
ORTHODONTICS

HEAD GEAR AND AUXILIARIES



Page 1 Protraction Face Mask

Page 2 Regular and Short Facebows

Page 3 Plain Inner Facebows and Bite Plate Facebows

Page 4 Angled Outer Facebows, Safety Release Modules, Neck Pads

Page 5 High Pull Head Caps, Kit Cases





Protraction Face Mask – Petite Versions

Fully adjustable forehead and chin rest to adapt to most patients. Traction angle determined by adjusting the elastics engagement bar. Includes extra set of chin/forehead pads (1 each) and allen wrench.

ITEM # 406 (South Korea)



ITEM # 406-R-PADS Replacement Pads
(1 each chin/forehead pads)



1/2" Extra Oral Elastics

- One bulk pack of 1,000 elastics.
- Natural only.

ITEM

450E-8 Size 1/2" x 8 oz.

450E-16 Size 1/2" x 16 oz.



Head Gear and Auxiliaries

Series 100 Facebows

.045 Inner Bows - .072 Outer Bows

Midline and size marked

	Size	Inner Bow Size	Regular Outer Bow	Short Outer Bow
FB100R – Regular (R) Outer Bow	0	76 mm	FB100R0	FB100S0
	1	83 mm	FB100R1	FB100S1
	2	90 mm	FB100R2	FB100S2
FB100S – Short (S) Outer Bow	3	97 mm	FB100R3	FB100S3
	4	104 mm	FB100R4	FB100S4
	5	111 mm	FB100R5	FB100S5
	6	118 mm	FB100R6	FB100S6
FB100 Plain Inner Bow			FB100R	FB100S

All Items sold as 1 per package



FB100R – Regular (R)



FB100S – Short (S)



Series 100 Facebows (Cont'd from previous page)



FB100 – Plain Inner

Bite Plate Facebows

	Size	Inner Bow Size	Regular Outer Bow	Short Outer Bow
	2	90 mm	CV100R2	CV100S2
Regular (R) shown	3	97 mm	CV100R3	CV100S3
Short (S) are special order as are hooks and eyelets.	4	104 mm	CV100R4	CV100S4
	5	111 mm	CV100R5	CV100S5

All Items sold as 1 per package





Head Gear and Auxiliaries

Series 100 Facebows – Angled 15°, Occlusal



.045 Inner Bows – .072 Outer Bows
Midline and size marked

Size	Inner Bow Size	Regular Outer Bow	Short Outer Bow
2	90 mm	FB100R2-150	FB100S2-150
3	97 mm	FB100R3-150	FB100S3-150
4	104 mm	FB100R4-150	FB100S4-150
5	111 mm	FB100R5-150	FB100S5-150

All Items sold as 1 per package

Safety Release Modules – Count exposed strap marks to determine force



Item 440-M Medium
10/Pkg.
Item 440-H Heavy
10/Pkg.

Mark Number	MEDIUM		HEAVY	
	Avg. Grams	Avg. Ounces	Avg. Grams	Avg. Ounces
1	225	8	291	10
2	315	11	414	15
3	391	14	524	19
4	472	17	613	22
5	575	21	730	26
6	671	24	875	31
7	762	27	966	35
8	879	31	1104	39
9	1101	39	1196	43

Cervical Cotton Neck Pads – 3 module attachment locations

ITEM

441-A Assorted – 2 ea. Blue, Pink, Teal, Purple, Black
Accent Color on Black Pad
10/Pkg.

ITEM

441-B All Black
10/Pkg.



Soft Cushioned Neck Pads – 3 module attachment locations

ITEM

441-SC All Black
10/Pkg.





High Pull Caps – 3 module attachment locations
Black synthetic woven material for durability/comfort.

ITEM #

442-A Assorted – 2 ea. Blue, Pink, Teal, Purple, Black
Accent Color on Black Pad
10/Pkg.

442-B All Black
10/Pkg.



Kit Cases

Durable nylon 10" x 7" zippered top cases hold facebow assemblies and protraction face mask (page 8-5). Metal ring allows securing to book bags or lockers.

Sold individually.

ITEM # (China)

445B Blue

445R Red

445G Green

445P Purple

445BI Black

INSTRUMENTS



Page 1 Introduction, Warranty, Sterilization Recommendations

Page 2 Distal, Ligature, and Hard Wire Cutters, Bird Beak and Tweed

Page 3 Three Prong, Band Remover, Arch Contouring, Angled Weingardt, Angled and Straight Bracket Remover, "V" Stop Plier for NiTi, NiTi Distal Bending

Page 4 Adhesive Removing and Separating Pliers, Mathieus, Bracket Holders, Coon Ligature, Angled Hook Crimping Pliers

Page 5 Cap Removing Plier, HD Explorer for Elastics Removing and SLB Opening, Boone Gauge, DSX Lubricant

Page 6 Bracket Holder, Bondable Tube Holders, Pusher/Scaler



Wire cutting, forming, and handling instruments are sourced from the highest quality American, German, and Japanese manufacturers.



All inserts on cutters and wire forming instruments are a proven anti-corrosive molybdenum, chrome vanadium material for long life.

Following each individual instrument description will be the country of origin. When "Phoenix" is stated, product is manufactured in USA.

Warranty – Lifetime on any failed insert that separates from the forging. One year on repair or replacement of any fractured insert.



- **Follow recommendations on capacities.**
- **Use of an ultrasonic cleaning solution with lubricant and corrosion inhibitors is required.**
- **For longer instrument life:**
 1. **Always sterilize mathieus and hemostats in the open and unlocked position.**
 2. **Cutting tips should be racked and held open while in ultrasonics to prevent rapid dulling.**





Distal End Cutter

Small pattern for easy access
Shear cut with hold
Capacity 012-020-022x028
ITEM # OE-318



Ligature Cutter

Small pattern for easy access
Capacity 010-014 soft wire only
ITEM # OE-304



Angled Ligature Cutter 15°

Capacity 010-014 soft wire only
ITEM # OE-311



Flush Cut Distal End Cutter

Cuts flush to distal of tube and holds wire. New smaller pattern and longer handles for better access.
Capacity 012-020-022x028
ITEM # 1016F



Hard Wire Cutter

Capacity 014-020-022x028
ITEM # OE-310



Bird Beak Standard

Capacity 020-032-022x028
ITEM # OE-330



Bird Beak for Intricate Bends and Full Control

Capacity .030
ITEM # 60-314 Japan



Arch Bending, Tweed

.043 wide beaks are parallel at .020 opening
Arch wire Capacity 022x028
ITEM # 60-303 Japan



Three Prong Standard

For detailing in the vertical and horizontal planes of ProForce nickel titanium.

Capacity .028

ITEM # 60-313 Japan



Three Prong Large

Capacity .036

ITEM # 60-313L Japan



Posterior Band Remover Long

ITEM # OE-354

ITEM # OE-942 tips (6)

Autoclavable 250°F



Arch Contouring

Inserted tips form shapes smoothly.

ITEM # PH203 Phoenix



Weingardt Angled Slip Tips for Best Access

ITEM # OE-814



Angled Bracket Remover

ITEM # OE-353



"V" Stop Plier for NiTi

Capacity 012-020-021x025

ITEM # OE-349



NiTi Distal Bender

ITEM # 60-900 Japan



Straight Bracket Remover

ITEM # OE-352



Phoenix Instruments



Adhesive Remover

ITEM # OE-933

ITEM # OE-1002 Steel tip (1)

ITEM # OE-942 tips (6)

Autoclavable 250°F



Separating Plier with Parallel Safe Tips

ITEM # OE-953



Mathieu Multi Purpose Tips for Elastomerics and Steel Ligatures

ITEM # PH-815



Reverse Action Bracket Holder

ITEM # OE-921



Reverse Action Bracket Holder With Bracket Height Gauge (MM)

ITEM # OE-925-BG



Mathieu Premium Slim Tips for Elastomerics Only – No Steel

ITEM # 30566 Japan



Coon Ligature Plier

ITEM # OE-791



Angled Hook Crimping Plier

Four prong design securely holds/
crimps hooks and stops on four sides.

ITEM # 60-446 Japan



Cap Removing Instrument

Convertible buccal tube (including bondable tubes) caps removed easily and comfortably. Will not debond tubes. Cold sterilize or 270°F.

Item # 60-105 Japan

Item # 60-960 Replacement Tips 5/Pkg. Japan

Item # 60-961 Hex Wrench



Heavy Duty Explorer

Tip does not flex when removing ligature modules or chains. Very useful for opening "doors" on self-ligating brackets, including our Embrace SLR.

Item # PH S/E 1



Boone Bracket Height Gauge

ITEM # 1346



DSX® Synthetic Lubricant for Hinged Instruments

ITEM # DSX-365

Fluoropolymer 0.02 micron particles fill the low spots in metal, reducing friction, impeding adherence of foreign bodies and repelling moisture. 4 oz. dropper bottle.



**Bracket/Tube Placing
Instrument**

ITEM # 20-009



Bondable Tube Holder

ITEM # OE-1343



**Reverse Action
Bondable Tube Holder**

ITEM # OE-1344



Pusher/Scaler

Stainless CE-USA

ITEM # PH-PSC

*Thank you for using
Phoenix products*

Visit our website at
phoenixorthodonticsgeorgia.com



PHOENIX
ORTHODONTICS

Page 1 Patient Wax, Chewies® Aligner
Tray Seaters

Page 2 Ultra-Guard® Mouth Guards





Ortho Wax Compacts

Smooth consistency for easy application and the “stickiness” to stay where placed.

100/Pkg.

ITEM # 400-W



Chewies™ Aligner Tray Seaters

10 patient packs of 2 each/Pkg.

ITEM # 413-W



Ultra-Guard® Mouth Guards

Ergonomically contoured for comfort and protection with free flow air channel.

10/Pkg.

WITH STRAP

Blue	444-004
Black	444-005
Red	444-001
Green	444-002
Yellow	444-003
Clear	444-006

NO STRAP

Blue	444-004NS
Black	444-005NS
Red	444-001NS
Green	444-002NS
Yellow	444-003NS
Clear	444-006NS

*Thank you for using
Phoenix products*

Visit our website at
phoenixorthodonticsgeorgia.com

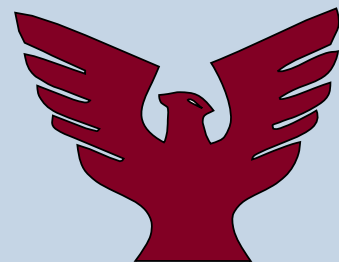

MISCELLANEOUS AND STORAGE



Page 1 Disposable Arch Markers,
Bracket Organizer, Bracket
Organizer Cabinet

Page 2 Disposable Bonding Pad,
Chain Dispenser

Page 3 Stand Up Arch Wire Rack,
Superior Arch Wire Racks





Disposable Arch Markers

ITEM # 400M "Red" Tip Wooden Markers
100/Pkg.



Bracket Organizer

5 5/8" x 2 1/2" White – with wells (Taiwan)
25/Pkg.

ITEM # 599-W



Bracket Organizer Cabinet with Slide In Front Cover

Holds 10 bracket organizer set up pads
6 3/8" wide, 6" tall, 3" deep

ITEM # 599-CAB (Taiwan)



Miscellaneous & Storage

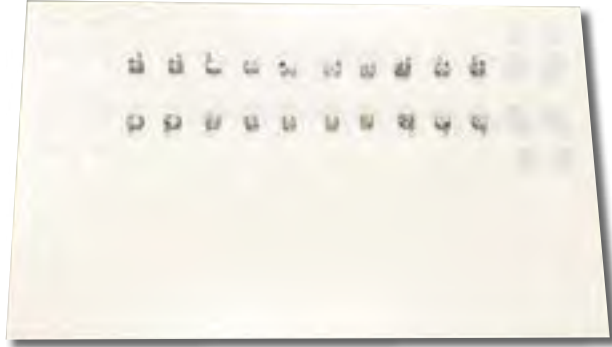

Disposable Bonding Pad

3 1/2" x 5 3/4" 25 sheets per pad

ITEM # 599-OGP

25/Pkg.



Chain Dispensers

18 chain capacity.

9 7/8" long x 3 7/8" wide x 4 1/4" O.D.

ITEM # 900-105 (Taiwan)



Standup Arch Wire Rack

White acrylic rack holds Phoenix arch wire bags displayed for easy identification – three row design for countertop use.

ITEM # 900-106



Superior Arch Wire Racks

Designed to hold Phoenix arch forms without distortion. 12 slot capacity, hinged dust cover, acrylic. 8 3/4" long x 4 1/2" wide x 4 1/2" tall - weighs 3 lbs.

ITEM # 900-103-A fits Symmetry (not "Small") and Symmetry II

ACRYLIC ORGANIZER CLEANING INSTRUCTIONS

For all acrylic racks and storage systems shown on pages 11-2 and 11-3, DO NOT USE ALCOHOL OR AMMONIA based cleaners as they will dry out the acrylic material and cracks will appear. USE ONLY soap and warm water to clean, or acrylic cleaners designed for those surfaces.

ORDER FORMS



PHOENIX ORTHODONTICS
Ph: 800-735-6029 / 770-643-8896
Fax: 770-643-1974

Customer Name _____
Address _____
Phone _____
Contact Person _____

BRACKETS/TUBES – Bondable S.S. 018 022 As per Previous Orders (Enter Quantity Only)

Upper Arch	Item Number	Quantity	Lower Arch	Item Number	Quantity
Central	R		Lower Anteriors - TOTAL		
	L				
Lateral	R				
	L				
Cuspid Hooks <input type="checkbox"/>	R		Cuspid Hooks <input type="checkbox"/>	R	
	L			L	
Bicuspid - 1st Hooks? <input type="checkbox"/>	R		Bicuspid - 1st Hooks? <input type="checkbox"/>	R	
	L			L	
Bicuspid - 2nd Hooks? <input type="checkbox"/>	R		Bicuspid - 2nd Hooks? <input type="checkbox"/>	R	
	L			L	
Bondable 1st - Molar	R		Bondable 1st - Molar	R	
	L			L	
Bondable 2nd - Molar	R		Bondable 2nd - Molar	R	
	L			L	

Line #	Description	Quantity
01		
02		
03		
04		
05		
06		
07		
08		
09		
10		
11		
12		
13		
14		
15		
16		
17		
18		
19		
20		

Thank you for your order!

Page 1 Bracket/Tubes Auxiliary Order Form

Page 2 Arch Wires Order Form

Page 3 iP Arch Wires Order Form

Page 4 Elastomeric Force Systems Order Form

Page 5 "Original" Series Order Form, Bands

Page 6 "M" Series Order Form, Bands



PHOENIX ORTHODONTICS
Ph: 800-735-6029 / 770-643-8896
Fax: 770-643-1974

Customer Name _____
Address _____
Phone _____
Contact Person _____

"Original" Series

Special Welding Instructions:

Maxillary 1st Molar		Mandibular 1st Molar		Maxillary 2nd Molar		Mandibular 2nd Molar		Maxillary Bicuspid		Mandibular Bicuspid	
Lingual Attachment		Lingual Attachment		Lingual Attachment		Lingual Attachment		Lingual Attachment		Lingual Attachment	
Buccal Tube	Buccal Tube	Buccal Tube	Buccal Tube	Bracket	Bracket	Bracket	Bracket	Bracket	Bracket	Bracket	Bracket
UR	UL	LR	LL	UR	UL	LR	LL	UR	UL	LR	LL
1	1	1	1	1	1	1	1	1	1	1	1
2	2	2	2	2	2	2	2	2	2	2	2
3	3	3	3	3	3	3	3	3	3	3	3
4	4	4	4	4	4	4	4	4	4	4	4
5	5	5	5	5	5	5	5	5	5	5	5
6	6	6	6	6	6	6	6	6	6	6	6
7	7	7	7	7	7	7	7	7	7	7	7
8	8	8	8	8	8	8	8	8	8	8	8
9	9	9	9	9	9	9	9	9	9	9	9
10	10	10	10	10	10	10	10	10	10	10	10
11	11	11	11	11	11	11	11	11	11	11	11
12	12	12	12	12	12	12	12	12	12	12	12
13	13	13	13	13	13	13	13	13	13	13	13
14	14	14	14	14	14	14	14	14	14	14	14
15	15	15	15	15	15	15	15	15	15	15	15
16	16	16	16	16	16	16	16	16	16	16	16
17	17	17	17	17	17	17	17	17	17	17	17
18	18	18	18	18	18	18	18	18	18	18	18
19	19	19	19	19	19	19	19	19	19	19	19
20	20	20	20	20	20	20	20	20	20	20	20
21	21	21	21	21	21	21	21	21	21	21	21
22	22	22	22	22	22	22	22	22	22	22	22
23	23	23	23	23	23	23	23	23	23	23	23
24	24	24	24	24	24	24	24	24	24	24	24
25	25	25	25	25	25	25	25	25	25	25	25
26	26	26	26	26	26	26	26	26	26	26	26
27	27	27	27	27	27	27	27	27	27	27	27
28	28	28	28	28	28	28	28	28	28	28	28
29	29	29	29	29	29	29	29	29	29	29	29
30	30	30	30	30	30	30	30	30	30	30	30
31	31	31	31	31	31	31	31	31	31	31	31
32	32	32	32	32	32	32	32	32	32	32	32
33	33	33	33	33	33	33	33	33	33	33	33
34	34	34	34	34	34	34	34	34	34	34	34
35	35	35	35	35	35	35	35	35	35	35	35
36	36	36	36	36	36	36	36	36	36	36	36
Total	Total	Total	Total	Total	Total	Total	Total	Total	Total	Total	Total
Ship	Ship	Ship	Ship	Ship	Ship	Ship	Ship	Ship	Ship	Ship	Ship



PHOENIX ORTHODONTICS

Ph: 800-735-6029 | 770-643-8896

Fax: 770-643-1974

Customer Name _____

Address _____

Phone _____

Contact Person _____

BRACKETS/TUBES – Bondable S.S. .018 .022 As per Previous Orders (Enter Quantity Only)

Upper Arch	Item Number	Quantity	Lower Arch	Item Number	Quantity
Central	R	R	Lower Anteriors - TOTAL		
	L	L			
Lateral	R	R			
	L	L			
Cuspid Hooks <input type="checkbox"/>	R	R	Cuspid Hooks <input type="checkbox"/>	R	R
	L	L		L	L
Bicuspid - 1st Hooks? <input type="checkbox"/>	R	R	Bicuspid - 1st Hooks? <input type="checkbox"/>	R	R
	L	L		L	L
Bicuspid - 2nd Hooks? <input type="checkbox"/>	R	R	Bicuspid - 2nd Hooks? <input type="checkbox"/>	R	R
	L	L		L	L
Bondable 1st - Molar	R	R	Bondable 1st - Molar	R	R
	L	L		L	L
Bondable 2nd - Molar	R	R	Bondable 2nd - Molar	R	R
	L	L		L	L

Line #	Description	Quantity
01		
02		
03		
04		
05		
06		
07		
08		
09		
10		
11		
12		
13		
14		
15		
16		
17		
18		
19		
20		

Thank you for your order!

To Place Orders: 800-735-6029 • Atlanta area 770-643-8896 • Fax 770-643-1974

orders@phoenixortho.com • www.phoenixorthodonticsgeorgia.com



PHOENIX ORTHODONTICS

Ph: 800-735-6029 | 770-643-8896

Fax: 770-643-1974

orders@phoenixorthoga.com

Customer Name _____

Address _____

Phone _____

Contact Person _____

ARCH WIRE ORDER FORM

Date: _____

Diameters	Thermal N/T Quantity	S/E N/T Quantity	Pro Force N/T Quantity	MTA Quantity	Stainless Steel Quantity	RCS Quantity
012U						
012L						
014U						
014L						
016U						
016L						
018U						
018L						
020U						
020L						
014x025U						
014x025L						
016x016U						
016x016L						
016x022U						
016x022L						
016x025U						
016x025L						
017x025U						
017x025L						
018x018U						
018x018L						
018x025U						
018x025L						
019x025U						
019x025L						
020x020U						
020x020L						
021x025U						
021x025L						

To Place Orders: 800-735-6029 • Atlanta area 770-643-8896 • Fax 770-643-1974

orders@phoenixorthoga.com • www.phoenixorthodonticsgeorgia.com



PHOENIX ORTHODONTICS

Ph: 800-735-6029 | 770-643-8896

Fax: 770-643-1974

orders@phoenixorthoga.com

Customer Name _____

Address _____

Phone _____

Contact Person _____

Symmetry *IP* ARCH WIRE ORDER FORM

Date: _____

Wire Size	Thermal N/T Quantity	S/E N/T Quantity	MTA Quantity	Stainless Steel Quantity
013U				
014U				
016U				
018U				
020U				
014x025U				
016x022U				
016x025U				
017x025 U				
018x025U				
019x025U				
018x018U				
020x020U				
013L2				
014L2				
016L2				
018L2				
020L2				
014x025L2				
016x022L2				
016x025L2				
017x025L2				
018x025L2				
019x025L2				
018x018L2				
020x020L2				
013L1				
014L1				
016L1				
018L1				
020L1				
014x025L1				
016x022L1				
016x025L1				
017x025L1				
018x025L1				
019x025L1				
018x018L1				
020x020L1				

To Place Orders: 800-735-6029 • Atlanta area 770-643-8896 • Fax 770-643-1974

orders@phoenixorthoga.com • www.phoenixorthodonticsgeorgia.com



PHOENIX ORTHODONTICS

Ph: 800-735-6029 | 770-643-8896

Fax: 770-643-1974

orders@phoenixorthoga.com

Customer Name _____

Address _____

Phone _____

Contact Person _____

ELASTOMERIC FORCE SYSTEMS ORDER FORM

Date: _____

Color Chip	Color Name	Abbreviation Code	Straight Tie #300	Quantity #300	Single Use Tie #301	Quantity #301	Key Tie #330	Quantity #330	Chain Elastic			
									Continuous #304	Quantity #304	Open #302	Quantity #302
	Aquamarine	Aq	300-Aq		301-Aq		330-Aq		304-Aq		302-Aq	
	Azure	Az	300-Az		301-Az		330-Az		304-Az		302-Az	
	Black	Bl	300-Bl		301-Bl		330-Bl		304-Bl		302-Bl	
	Blue	B	300-B		301-B		330-B		304-B		302-B	
	Bubble Gum	Bg	300-Bg		301-Bg		330-Bg		304-Bg		302-Bg	
	Clear	Cl	300-Cl		301-Cl		330-Cl		304-Cl		302-Cl	
	Cobalt	Cb	300-Cb		301-Cb		330-Cb		304-Cb		302-Cb	
	Coral	C	300-C		301-C		330-C		304-C		302-C	
	Green	Gn	300-Gn		301-Gn		330-Gn		304-Gn		302-Gn	
	Grey	Gr	300-Gr		301-Gr		330-Gr		304-Gr		302-Gr	
	Gold	Gd	300-Gd		301-Gd		330-Gd		304-Gd		302-Gd	
	Lavender	L	300-L		301-L		330-L		304-L		302-L	
	Light Blue	Lb	300-Lb		301-Lb		330-Lb		304-Lb		302-Lb	
	Lime Green	LiG	300-LiG		301-LiG		330-LiG		304-LiG		302-LiG	
	Maroon	M	300-M		301-M		330-M		304-M		302-M	
	Mint	Mi	300-Mi		301-Mi		330-Mi		304-Mi		302-Mi	
	Navy	N	300-N		301-N		330-N		304-N		302-N	
	Orange	O	300-O		301-O		330-O		304-O		302-O	
	Perfect Pink	Pp	300-Pp		301-Pp		330-Pp		304-Pp		302-Pp	
	Purple	P	300-P		301-P		330-P		304-P		302-P	
	Red	R	300-R		301-R		330-R		304-R		302-R	
	Silver	Sv	300-Sv		301-Sv		330-Sv		304-Sv		302-Sv	
	Smoke	S	300-S		301-S		330-S		304-S		302-S	
	Violet	V	300-V		301-V		330-V		304-V		302-V	
	White	W	300-W		301-W		330-W		304-W		302-W	
	Yellow	Y	300-Y		301-Y		330-Y		304-Y		302-Y	
	Porcelain	PO			301-PO		330-PO		304-PO		302-PO	

To Place Orders: 800-735-6029 • Atlanta area 770-643-8896 • Fax 770-643-1974

orders@phoenixorthoga.com • www.phoenixorthodonticsgeorgia.com



“Original” Series

PHOENIX ORTHODONTICS

Ph: 800-735-6029 | 770-643-8896

Fax: 770-643-1974

Customer Name _____

Address _____

Phone _____

Contact Person _____

Special Welding Instructions:

Maxillary 1st Molar			Mandibular 1st Molar			Maxillary 2nd Molar			Mandibular 2nd Molar			Maxillary Bicuspid			Mandibular Bicuspid		
Lingual Attachment			Lingual Attachment			Lingual Attachment			Lingual Attachment			Lingual Attachment			Lingual Attachment		
Buccal Tube			Buccal Tube			Buccal Tube			Buccal Tube			Bracket			Bracket		
UR			LR			UR			LR			UR			LR		
UL			LL			UL			LL			UL			LL		
	UR	UL		LR	LL		UR	UL		LR	LL		UR	UL		LR	LL
1			1			1			1			1			1		
2			2			2			2			2			2		
3			3			3			3			3			3		
4			4			4			4			4			4		
5			5			5			5			5			5		
6			6			6			6			6			6		
7			7			7			7			7			7		
8			8			8			8			8			8		
9			9			9			9			9			9		
10			10			10			10			10			10		
11			11			11			11			11			11		
12			12			12			12			12			12		
13			13			13			13			13			13		
14			14			14			14			14			14		
15			15			15			15			15			15		
16			16			16			16			16			16		
17			17			17			17			17			17		
18			18			18			18			18			18		
19			19			19			19			19			19		
20			20			20			20			20			20		
21			21			21			21			21			21		
22			22			22			22			22			22		
23			23			23			23			23			23		
24			24			24			24			24			24		
25			25			25			25								
26			26			26			26								
27			27			27			27								
28			28			28			28								
29			29			29			29								
30			30			30			30								
31			31			31			31								
32			32			32			32								
33			33			33			33								
34			34			34			34								
35			35			35			35								
36			36			36			36								
Total			Total			Total			Total			Total			Total		
Ship			Ship			Ship			Ship			Ship			Ship		

To Place Orders: 800-735-6029 • Atlanta area 770-643-8896 • Fax 770-643-1974

orders@phoenixorthoga.com • www.phoenixorthodonticsgeorgia.com



“M Series”

PHOENIX ORTHODONTICS

Ph: 800-735-6029 | 770-643-8896
 Fax: 770-643-1974

Customer Name _____
 Address _____

 Phone _____
 Contact Person _____

Special Welding Instructions:

Special Welding Instructions:																	
Maxillary 1st Molar			Mandibular 1st Molar			Maxillary 2nd Molar			Mandibular 2nd Molar			Maxillary Bicuspid			Mandibular Bicuspid		
Lingual Attachment			Lingual Attachment			Lingual Attachment			Lingual Attachment			Lingual Attachment			Lingual Attachment		
Buccal Tube			Buccal Tube			Buccal Tube			Buccal Tube			Bracket			Bracket		
UR			LR			UR			LR			UR			LR		
UL			LL			UL			LL			UL			LL		
	UR	UL		LR	LL		UR	UL		LR	LL		UR	UL		LR	LL
29.5			29.5			29.5			29.5			1			1		
30			30			30			30			2			2		
30.5			30.5			30.5			30.5			3			3		
31			31			31			31			4			4		
31.5			31.5			31.5			31.5			5			5		
32			32			32			32			6			6		
32.5			32.5			32.5			32.5			7			7		
33			33			33			33			8			8		
33.5			33.5			33.5			33.5			9			9		
34			34			34			34			10			10		
34.5			34.5			34.5			34.5			11			11		
35			35			35			35			12			12		
35.5			35.5			35.5			35.5			13			13		
36			36			36			36			14			14		
36.5			36.5			36.5			36.5			15			15		
37			37			37			37			16			16		
37.5			37.5			37.5			37.5			17			17		
38			38			38			38			18			18		
38.5			38.5			38.5			38.5			19			19		
39			39			39			39			20			20		
39.5			39.5			39.5			39.5			21			21		
40			40			40			40			22			22		
40.5			40.5			40.5			40.5			23			23		
41			41			41			41			24			24		
41.5			41.5			41.5			41.5								
42			42			42			42								
42.5			42.5			42.5			42.5								
43			43			43											
43.5			43.5			43.5											
44			44			44											
Total			Total			Total			Total			Total			Total		
Ship			Ship			Ship			Ship			Ship			Ship		

To Place Orders: 800-735-6029 • Atlanta area 770-643-8896 • Fax 770-643-1974

orders@phoenixorthoga.com • www.phoenixorthodonticsgeorgia.com



PHOENIX
ORTHODONTICS

**P.O. Box 71773
Marietta, GA 30007**

Toll Free: 800-735-6029

Phone: 770-643-8896

Fax: 770-643-1974

orders@phoenixorthoga.com

www.phoenixorthodonticsgeorgia.com