

LAB SUPPLIES



Page 1 Leone 620 Palatal Expanders, Keys, Leash, Swivel Keys, Bending Instrument

Page 2 Leone Palatal Expanders with Pre-Bent Arms

Page 3 Leone Micro Palatal Expanders

Page 4 Leone Lower Arch Expanders, Fan Type Expanders

Page 5 Micro Palatal Expander “Easy Access”

Page 6 Leone Self Activating Nitinol Leaf Expanders, Gauge

Page 7 Flat Bow Retainer Wires, Adams Clasps

Page 8 Lab Wires – Stainless Steel, Blue Temp, MTA, Ball Clasps

Page 9 Preformed Lip Bumper with Loops, Thermal Insulator Paste

Page 10 Silver Solder, Solder Flux, Disposable Impression Trays

Page 11 Select Retainer Cases

Page 12 Mini Retainer Cases, Standard Retainer Cases



Leone Rapid Expander

Made entirely of biomedical stainless steel. The housing design is completely smooth, with no rough areas for a secure hygiene. The expander limit, a directional arrow and the lot number are laser etched into the surface of the expander body. Supplied with a swivel key with handle and instructions for use to facilitate the patient endoral activation.

1/Pkg. Italy

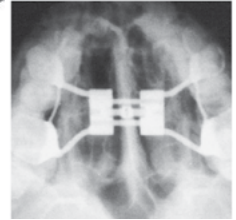

	CODE	\varnothing	\longleftrightarrow			ACTIVATION TURNS
11 mm 4 mm		arms mm	body mm	mm	mm	for maximum expansion limit
	A0620-08	1,5	12	8	0,8	35
	A0620-09	1,5	14	9	0,8	40
	A0620-11	1,5	16	11	0,8	50
	A0620-13	1,5	18	13	0,8	60
	A0620-15	1,5	20	15	0,8	70



Leash

100/Pkg. (Italy)

ITEM

A0557-02

Swivel Key

10/Pkg.

ITEM

414

Arm Bending Instrument for Rapid Expansor

Allows for easy bending once inserted into the rapid Expansor arm. (Italy)

ITEM

P1620-01

Straight Keys

100/Pkg. (Italy)

ITEM

A0557-00

Bent Tip Keys

100/Pkg. (Italy)

ITEM

A0557-01



Lab Supplies – Leone Expansor® Series







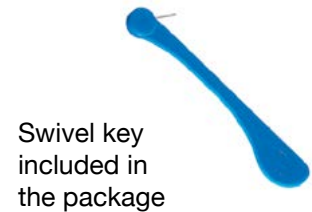



Leone Rapid Expander With Pre-Bent Arms

Exactly the same as A0620 expander for all technical features and materials used, but designed with pre-bent arms to facilitate the work in the laboratory. The front arms are more inclined than the rear arms to allow the positioning of the expander's body in the most comfortable way for the patient with the best biomechanical results. Provided with one swivel key with handle and instructions for use to facilitate the patient endoral activation.

1/Pkg. Italy



Swivel key included in the package

 11 mm	 4 mm	CODE	 arms mm	 body mm	 mm	 mm	ACTIVATION TURNS
							for maximum expansion limit
		A0620W08	1,5	12	8	0,8	35
		A0620W09	1,5	14	9	0,8	40
		A0620W11	1,5	16	11	0,8	50
		A0620W13	1,5	18	13	0,8	60











Leone Micro Rapid Expander with Telescopic Guides

The innovative telescopic guides assure a constant friction throughout the expansion movement, a perfect stability and small sizes. It self deactivates when maximum expansion capacity has been achieved preventing from over-treatment. The 7 mm expander is ideal to treat very narrow palates.

The expanders with 10 and 12 mm sizes feature a compact design for ease of arm bending and reducing the overall dimensions of the device.

Supplied with a swivel key with handle and instructions for use to facilitate patient endoral activation.

1/Pkg. Italy

	 11 mm	 4 mm	 arms	 body			activation turns for maximum expansion limit
 A2620-07			1,5 mm	11 mm	7 mm	0,8 mm	35
 A2620-10			1,5 mm	14 mm	10 mm	0,8 mm	50
 A2620-12			1,5 mm	16 mm	12 mm	0,8 mm	60

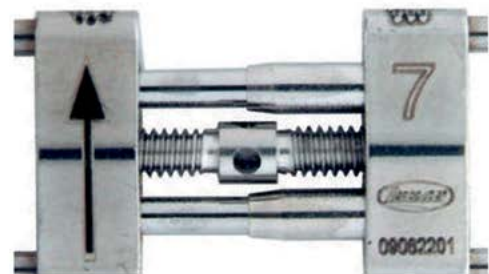

Telescopic Guide Pins*

Avoid the possibility of spontaneous deactivation in the mouth.

*International patent



Lab Supplies – Leone Expander Series



Leone Expander for Lower Arch

As a result of various marketing requests, we introduce the expander with longer arms compared to the previous model.

1/Pkg. Italy



Key with safety ring leash included in the package

7,5 mm	4 mm	arms 1,5 mm	body	activation turns for maximum expansion limit
		A0623-08		12 mm 8 mm 0,8 mm 35
		A0623-11		16 mm 11 mm 0,8 mm 50

Leone Ragno Fan-Type Rapid Expander and Mini Rapid Expander



Conceived with the cooperation of Dr. Eleonora Schelliono and Prof. Remo Modica Made entirely of biomedical stainless steel. The expanding arms are laser welded to the screw body. Laser engraved directional arrows on the MIM® body. It is a device for the rapid expansion of the palate that allows you to get a widening of the single anterior sector of the maxillary arch, still maintaining the expansion at the molar level. It self-deactivates when maximum expansion capacity has been achieved preventing from overtreatment. The difference between the two models is the geometric shape of the palate trying to determine the minimum encumbrance. The overall size is approximately 20-25% mm less than those of the 9 mm version. Provided with one swivel key with handle and instructions for use to facilitate the patient endoral activation.

1/Pkg. Italy

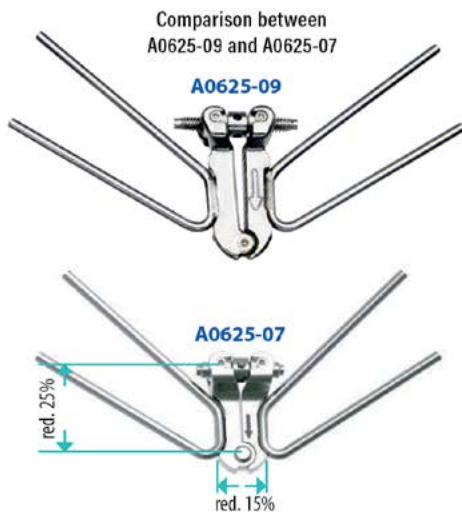

			activation turns for maximum expansion limit
A0625-09	9 mm	0,9 mm	40
A0625-07	7 mm	0,9 mm	31



MICRO EXPANDER FOR PALATAL SUTURE

EASY ACCESS

A1621 expander called “Easy Access” is comparable to the existing A0621, but once placed in the device, the body of the screw will remain closer to the palate with minimized overall dimensions; the head with activation holes remains in front position in respect to the guide pin for easier activation with the key.

Provided with one swivel key with handle and instructions for use to facilitate the patient endoral activation.

The arm bending and self-locking instrument is also available.

1/Pkg.



Swivel key included in the package



anterior position

holes of activation



easy access

for key activation

3 expansion value

for any therapeutic treatment

						activation turns	
4,95 mm	4,05 mm	arms 1,5 mm	0,8 mm	body mm		for maximum expansion limit	
					12	8	35
A1621-08							
					16	11	50
A1621-11							
					18	13	60
A1621-13							









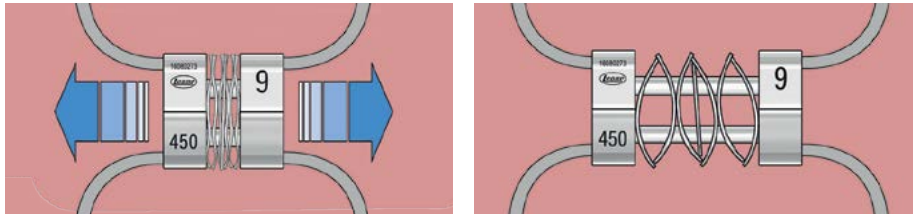

Leone Leaf Self Expander (Patented)

Featuring all the advantages of the Leaf expander without the need of periodic reactivation. The work of this expander is assigned entirely to the flexible properties of the nickel titanium leaf springs releasing controlled and continuous forces. The choice of the expander is decided on the basis of the transverse discrepancy of the patient; therapy is therefore predetermined and no further action is required, neither by the clinician nor even by the patient. Available in two strength levels and two expansion capabilities to meet nearly all maxillary deficiencies.

1/Pkg. Italy



			CODE			
	11 mm	4 mm		arms mm	body mm	mm
			A2705-06 4 springs 450 g approx	1,5	12	6
			A2706-06 4 springs 900 g approx	1,5	12	6
			A2705-09 6 springs 450 g approx	1,5	12	9
			A2706-09 6 springs 900g approx	1,5	12	9

A2700-00 EXPANSION MEASURING GAUGE FOR LEAF EXPANDER*

Helpful to verify the expansion gained from the MEMORIA Leaf Spring Activated Expander and the need to activate the expander or compress the springs again. Easy to place design, it makes easier to check the expansion value directly into the mouth.

Made of steel, suitable for hot and cold sterilization.

1/Pkg.





Loops Angulated labially
7° for comfort

Flat Bows

.032 Stainless Steel Resilient Wires
Flattened Anterior Segment for Torque Control
10/Pkg.

		ITEM #
Size 1	28.5 mm	400 FB1
Size 2	31 mm	400 FB2
Size 3	35 mm	400 FB3
Size 4	38 mm	400 FB4
Size 5	41.3 mm	400 FB5
Size 6	44.5 mm	400 FB6
Size 7	47.6 mm	400 FB7
Size 8	50.8 mm	400 FB8

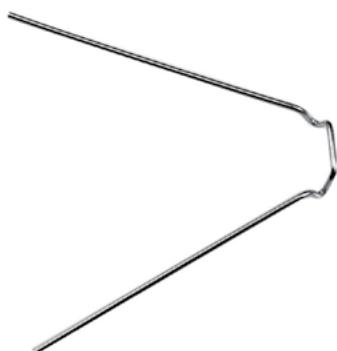

Sizes measured from
midline of loop to
midline of loop.

Adams Clasps

.028 Stainless Steel
100/Pkg.

	ITEM #
5 mm	409-5
6 mm	409-6
7 mm	409-7
8 mm	409-8
9 mm	409-9
10 mm	409-10
11 mm	409-11
12 mm	409-12



Stainless Steel Lab Wires

Pkg. of 10 x 14" Spring Temper

SIZE	ITEM #	SIZE	ITEM #
016	113-16	016 x 016	113-16x16
018	113-18	016 x 022	113-16x22
020	113-20	017 x 025	113-17x25
024	113-24	018 x 022	113-18x22
028	113-28	018 x 025	113-18x25
030	113-30	019 x 025	113-19x25
032	113-32	021 x 025	113-21x25
036	113-36		
040	113-40		
045	113-45		
051	113-51		
056	113-56		
060	113-60		



Blue Temp (Nickel Cobalt) Lab Wires

Pkg. of 25 x 14"

SIZE	ITEM #
028	113NC-28
030	113NC-30
032	113NC-32
036	113NC-36



MTA (Molybdenum Titanium Alloy) Lab Wires

Nickel Free Lab Wires

Pkg. of 10 x 14

SIZE	ITEM #
016	251-16
018	251-18
016 x 022	251-16x22
017 x 025	251-17x25
019 x 025	251-19x25
027	251-27
032	251-32
036	251-36



Ball Clasps Stainless Steel

Smooth, round head is twice the diameter of wire size.

100/Pkg.

SIZE	ITEM #
028	410-28
032	410-32
036	410-36



Lip Bumper

.045 with Loops

1/Pkg.
(Italy)

ITEM #
M3051-00



Thermal Insulator Paste

Highly visible green paste protects parts (stainless steel, plaster and resin) from being damaged by heat during soldering. Excellent consistency – easily removed with water.

235ml / 9 oz. Tube (Italy)

ITEM #
RO227-01



Silver Solder .025
(cadmium free) **ITEM #**
5 DWT 418-5
80 DWT 418-80



White Flux
2 oz. Jar **ITEM #**
423

Disposable Impression Trays

Rigid plastic trays with long handles for easy use. Rolled edges and open slots secure the alginate – no adhesives needed. Six sizes available numbered 1-6 and color coded. Sizes 1 and 2 are primarily pediatric and size 6 is extra large.

50/Pkg. One Size Upper or Lower

	ITEM #
Red Lower	400-IT1L
Red Upper	400-IT1U
Orange Lower	400-IT2L
Orange Upper	400-IT2U
Blue Lower	400-IT3L
Blue Upper	400-IT3U
Green Lower	400-IT4L
Green Upper	400-IT4U
Yellow Lower	400-IT5L
Yellow Upper	400-IT5U
Purple Lower	400-IT6L
Purple Upper	400-IT6U





Select Retainer Cases

Bright patient-pleasing colors and well made from strong high-impact plastic for maximum protection.

Sized to hold most retainers, appliances, and mouthguards. Ventilation holes, durable long life hinge, and inside clips to hold appliance keys.

1 3/8" deep, 3" wide, 2 3/4" front to back.

12/Pkg. of one color

ITEM #	400R-PI	400R-R	400R-B	400R-T	400R-BL	400R-O	400R-LB	400R-PL	400R-CL
	Pink	Red	Blue	Teal	Black	Orange	Light Blue	Plum	Clear





Mini Retainer Cases

Holds one vacuum formed Retainer (ideal when the lower retainer is bonded).
3/4" deep, 3" wide, 2 3/8" front to back.
12/Pkg. with labels
(Taiwan)

Colors – Black, Light Blue, Lime Green, Red, Violet, Yellow, Orange, and Pinki



ITEM #	400R-MINI-BL Black	400R-MINI-B Blue	400R-MINI-G Green	400R-MINI-O Orange
	400R-MINI-PK Pink	400R-MINI-P Purple	400R-MINI-R Red	400R-MINI-Y Yellow

Standard Retainer Cases

Holds two Hawley Style Retainers.
1" deep, 3 1/8" wide, 2 5/8" front to back.
50 per box with labels

Cool Colors – 10 each of Aqua, Pink, Orange, Yellow, and Purple

ITEM #
400-RC



*Thank you for using
Phoenix products*

Visit our website at
phoenixorthodonticsgeorgia.com

